

MORE SENATOR. MORE YOU.

Pens and Mugs
Catalogue **2018**



senator[®]
Extramoreordinary. Since 1920.



Dear Customers, dear Friends,

Thank you for giving us this opportunity to present you our senator® products for 2018 in this catalogue. Once again, as your dependable partner, we have made continuity a top priority:

- We are proud of our local production in Germany - this year we are investing more than € 1,000,000 in our headquarters in Groß-Bieberau (near Frankfurt).
- What we provide is a clear understandable portfolio designed to put brands in the spotlight - we also ensure stable pricing and product structures for all follow-up orders.
- We do everything in our power for you, every day - each of our 300-strong workforce is personally active to ensure that your order is in the best of hands.

Why do we do all of this? Our overriding goal is to know you are satisfied and will recommend us to others. After all, only when your customers have a positive association with your promotional products in the form of writing instruments, cups and mugs will we have done our job properly.

We take this as an incentive - every single day.

Yours sincerely,

Daniel Jeschonowski
Managing Partner, Senator GmbH

PS: In 2018 we are again able to present many interesting innovations - innovations which include the twist ball pen Bridge with a perfect soft touch surface and the King Can featuring sublimation technology. Please check out the following pages. They also show all the products we can customise for you, ready for dispatch within just five days. Obviously without any extra charge

MORE SENATOR. MORE YOU.

senator® products stand out because they represent a thorough concept targeting individualised brand presentation: a broad range of designs, dependable production and customised printing mean they offer a perfect match with your brand.



Quality made in Germany: since 1920

Our value chain within Germany and our many years of production know-how are your assurances for long life products to achieve advertising success.

Perfect print technology for every brand identity

The full range of spectacular printing options for our writing instruments and mugs are the guarantees to provide the best presentation for your brand identities.

We can help you in selecting the most suitable branding options, and design your promotional items to leave lasting impressions.

We accept responsibility for your safety

We produce with care and passion. That is something you can depend on. Senator® products are always the safe choice and fulfil all legal requirements. We are certified in accordance with ISO 9001, 14001, BSCI, SEDEX (UK).

Individual production and speedy delivery

Our closeness to the market and our technical possibilities mean we can respond both flexibly and very quickly: also to your short-term needs.

Strong promo articles on desktops

senator® ball pens and cups are the perfect accompaniment during every-day work. They boast persuasive functionality to help them quickly become products which are used every day, providing the ideal vehicle for advertising logos again and again, day by day.

CONTENTS

PLASTIC PENS

Bridge

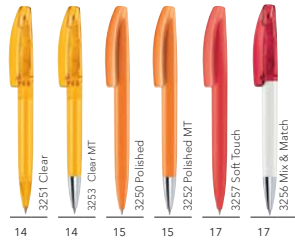

Liberty

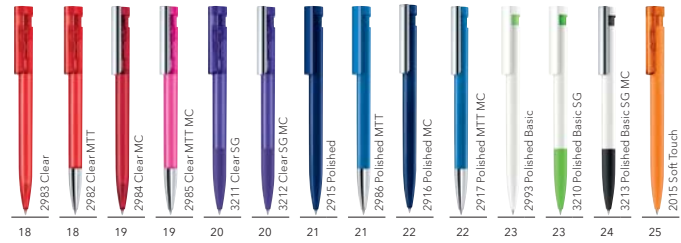

Challenger



Challenger



Dart



Super Hit

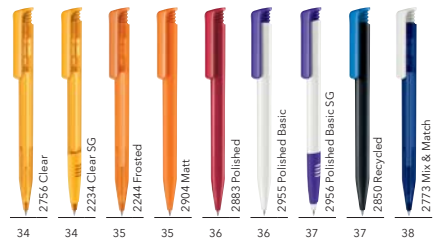

Point



Hatrix

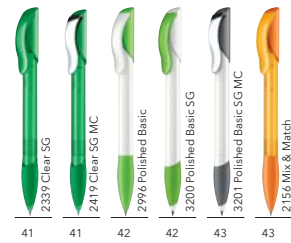

Centrix



Big Pen



Nature Plus



New Spring

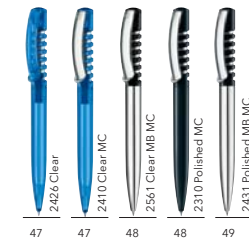

Soft-Spring



Matrix



Duo Pen



METAL PENS

Polar



Devon



Star Tec



Delgado



Delgado



Nautic



Nautic



Visir



Signer Liner



Image



Image



Carbon Line



Carbon Line



Tizio



Solaris



CASES

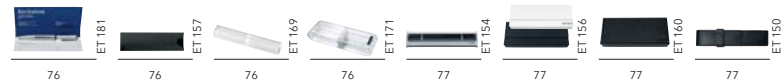

SERVICES

Branding Methods

108

Refills

110

CONTENTS

TO GO



SUBLIMATION MUGS

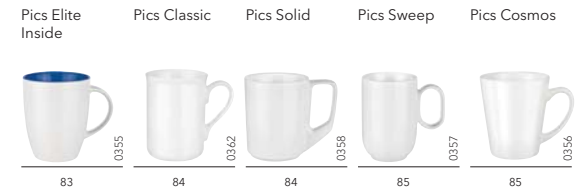
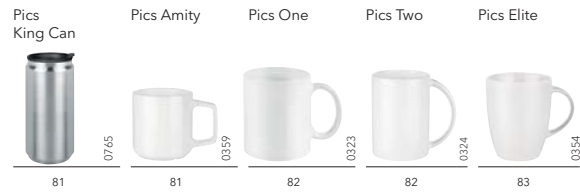

GLASS

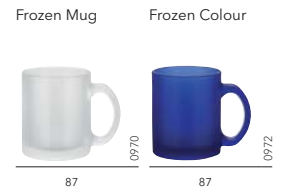

MUGS

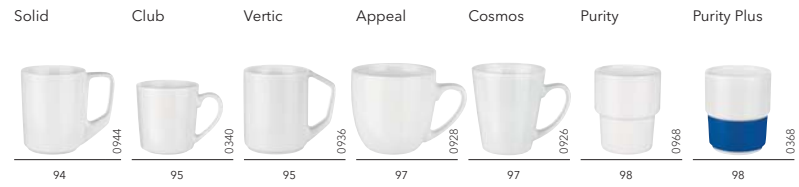
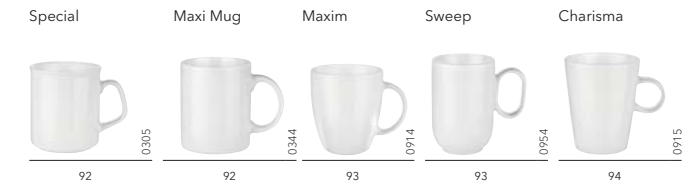
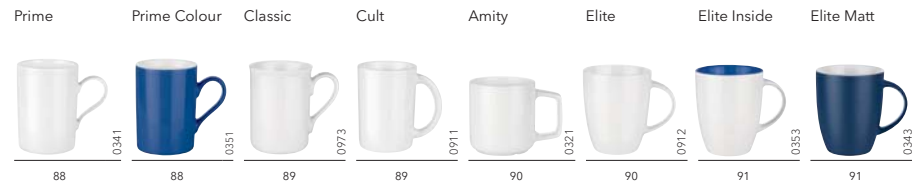

SETS

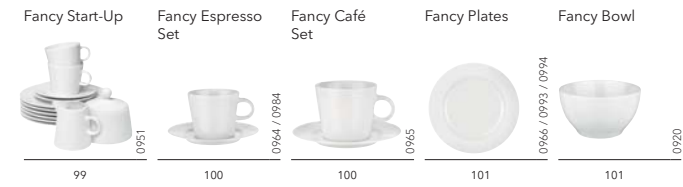

SETS

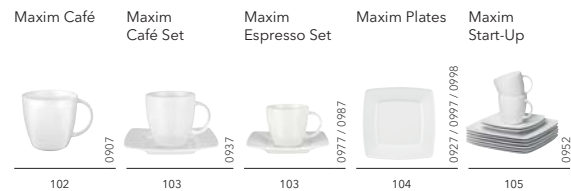

SERVICES

Packaging	Branding Methods
106	112

SENATOR SERVICE FOR YOU.

Our products are the vehicles for individual advertising concepts. We would be happy to provide support for your projects as well: with our products, with personal consultation and creative support as well as our speedy delivery service.



Use strong design suggestions for persuasion

You'd like to present your customers attractive design proposals for their projects?

Our visual service is the ideal partner. Send us a logo, tell us your requirements and we'll do the rest. We will send you a presentation reflecting your requirements for presentation to your customer.

Upon request we can also help make the product choice and also provide all creative work needed. Simply get in touch.



Our guarantee for quick deliveries

You, too, can benefit from the advantages of the unique senator® "5000 in 5" services.

All of your orders for volumes of up to 5,000 pieces will be produced within 5 days, including up to 5-colour printing, packaging and ready for dispatch. All at no extra charge. That is the service we offer you.

For all products marked with this logo, the following applies:

5,000 PENS IN 5 DAYS

- 5 days production period from approval of the position sketch
- up to 5,000 pens
- up to 5-colour printing (1 print position, branding methods A and C)
- valid for all colours of the respective model
- all model with choice of blue or black ink



For extra fast deliveries

We can now satisfy even the most express orders for our customers. Up to 1,000 ball pens, printed with one colour customer logo or advertising message, ready to dispatch within just 2 days.

This choice covers a range of 6 model variations in popular colours and surfaces in this extra fast delivery service.

1,000 PENS IN 2 DAYS

If all of the above is too slow, use our Pen Express Service:

- only 2 days production time from approval of position sketch
- up to 1,000 pens
- 1-print colour (barrel print, 1 print position)
- blue refill

OUR FAST DELIVERY SERVICE

5000 in 5 Models



Pen Express Models



6 COLOURS

Pen Express applies to 6 models in 6 strong promotional colours:



OUR COLOURS FOR YOUR SUCCESS.

With senator® your corporate colour is in safe hands. The colours available for senator® ball pens offer a broad choice of surfaces and models. This gives more flexibility when selecting the best promotional ball pen to perfectly fulfil your needs.

10 Top colours	151	7408	376	347	2757
	186	267	2935	CoolGr.9	Black
15 Standard colours	201	RhodRed	Hex.Cyan	445	White
	202	255	2735	3145	7699
25 Liberty colours	Red032	804	Yellow	7484	7519

10 TOP-COLOURS

Our basic models offer a combination of white with various colour accents. These basic models, as well as our transparent Hatrix and Liberty models with soft grip zone are available in our top 10 colours.

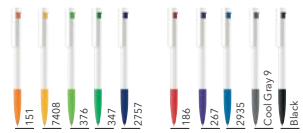

15 STANDARD COLOURS

In order to ensure you have the biggest possible choice and comparison, most of our plastic ball pens are available in our 15 standard colours per surface.

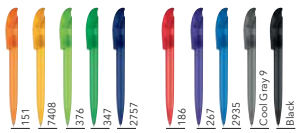

25 LIBERTY COLOURS

Our successful Liberty model also has an unbeatable colour range. In addition to the 15 standard colours Liberty is available in 10 additional transparent or opaque barrel colours.

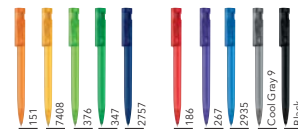

NEW

LONG-TERM COLOUR GUARANTEE

We guarantee that our 15 standard colours will be available unchanged in the years ahead. You can depend on being able to make follow-up orders in the future for many years from the senator® range for your original colour tone choice.

MIX & MATCH

Many of our models are available to mix between colours and finishes. Our Mix and Match service offers exactly that: a full range of surfaces, colours and additional options.

This means an unbelievable range of combinations and possibilities, and means that your promotional ball pens can be as unique as your brand.

To find out more: see over page.



PMS SERVICE

You can't find your preferred colour in our catalogue products? Then check our PMS service, which will definitely offer you the right option. Simply tell us the PANTONE® number of your preferred colour and we will produce either the pen in its entirety or only specific parts with your preferred tone.

This service does require certain minimum quantities. For details, please refer to the respective product.

In order to give your approval to the PMS service, we send you a sample piece produced with your preferred colour. To achieve an even higher degree of colour security (for example for the clear or frosted surfaces) we can also on request produce a pre-production sample in advance.



Our colour references always refer to the PANTONE® Matching System, however we must point out that the product itself - because of different surfaces, lighting and materials - can differ from the colour tone printed on paper. This is why we cannot accept complaints for such deviations.

MIX AS YOU LIKE.

Customise our pens to fit your corporate design using the senator® Mix & Match Service: mix colours, finishes and additional components to make the perfect pen for your brand.

Colour Mix:

Mix all available colours for each component of your chosen model to compliment your brand.

Material Mix:

Choose from the available surfaces for each component (excluding soft grip zones) and complete with an optional metal tip/clip.

We will happily create a visual for your individual pen if required.

MIX & MATCH MODELS



The senator® Mix & Match Service is available in a wide range of senator® ball pen families. We hold a broad range of surfaces, colours and configurations.



BRIDGE Clear

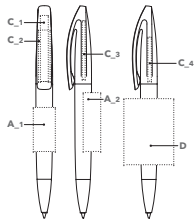

ART. NO. 3251
Twist ball pen
Glossy transparent body and clip surface,
senator® magic flow G2 refill (1.0 mm)
ink colour: blue or black

SERVICES
5,000 in 5, see page 9
PMS Service: from 20,000 pieces, see page 11



BRANDING / AREA

A_1 Screen print	30 x 15 mm	C_3 Tampo print	40 x 2 mm
A_2 Screen print	40 x 12 mm	C_4 Tampo print	30 x 3 mm
C_1 Tampo print	45 x 5 mm	D Barrel print 360°	45 x 34 mm
C_2 Tampo print	35 x 8 mm		

3251 3251

BRIDGE Polished

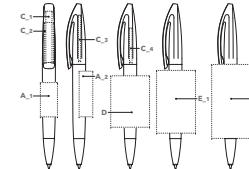

ART. NO. 3250
Twist ball pen
Glossy opaque body and clip surface,
senator® magic flow G2 refill (1.0 mm)
ink colour: blue or black

SERVICES
5,000 in 5, see page 9
PMS Service: from 20,000 pieces, see page 11



BRANDING / AREA

A_1 Screen print	30 x 15 mm	C_3 Tampo print	40 x 2 mm
A_2 Screen print	40 x 12 mm	C_4 Tampo print	30 x 3 mm
C_1 Tampo print	45 x 5 mm	D Barrel print 360°	45 x 34 mm
C_2 Tampo print	35 x 8 mm	E_1 HD print 360° on white barrel	55 x 34 mm
		E_2 HD print 360° XL on white barrel	65 x 34 mm

3250 3250

BRIDGE Clear MT

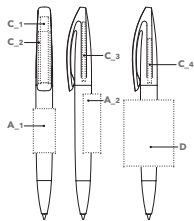

ART. NO. 3253
Twist ball pen
Glossy transparent body and clip surface,
glossy metal tip,
senator® magic flow G2 refill (1.0 mm)
ink colour: blue or black

SERVICES
PMS Service: from 20,000 pieces, see page 11



BRANDING / AREA

A_1 Screen print	30 x 15 mm	C_3 Tampo print	40 x 2 mm
A_2 Screen print	40 x 12 mm	C_4 Tampo print	30 x 3 mm
C_1 Tampo print	45 x 5 mm	D Barrel print 360°	45 x 34 mm
C_2 Tampo print	35 x 8 mm		

3253 3253

BRIDGE Polished MT

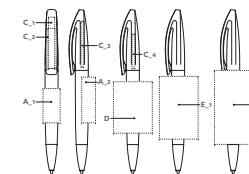

ART. NO. 3252
Twist ball pen
Glossy opaque body and clip surface,
glossy metal tip,
senator® magic flow G2 refill (1.0 mm)
ink colour: blue or black

SERVICES
PMS Service: from 20,000 pieces, see page 11



BRANDING / AREA

A_1 Screen print	30 x 15 mm	C_3 Tampo print	40 x 2 mm
A_2 Screen print	40 x 12 mm	C_4 Tampo print	30 x 3 mm
C_1 Tampo print	45 x 5 mm	D Barrel print 360°	45 x 34 mm
C_2 Tampo print	35 x 8 mm	E_1 HD print 360° on white barrel	55 x 34 mm
		E_2 HD print 360° XL on white barrel	65 x 34 mm

3252 3252



NEW



BRIDGE

TWIST AND SHOUT. TRUST AND SAVE.

Strong colours and an elegantly detailed design form a ball pen with character.

BRIDGE
Soft Touch

NEW



3257 3257

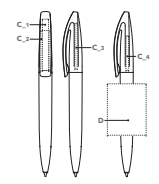

ART. NO. 3257

Twist ball pen
Velvety matt barrel surface
senator® magic flow G2 refill (1.0 mm),
ink colour: blue or black
Available from March 2018

SERVICES

PMS Service: from 10,000 pieces,
see page 11

COLOURS



BRANDING / AREA

C_1 Tampo print	45 x 5 mm	C_4 Tampo print	30 x 3 mm
C_2 Tampo print	35 x 8 mm	D Barrel print 360° (from 1,000 pcs.)	45 x 34 mm
C_3 Tampo print	40 x 2 mm		

BRIDGE
Mix & Match

NEW

MADE IN GERMANY
HD PRINT

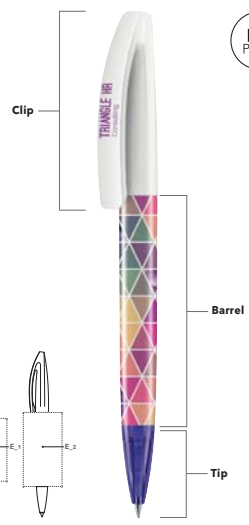

3256

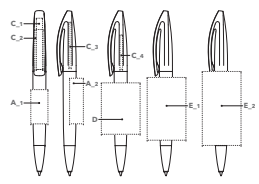

ART. NO. 3256

Twist ball pen
Free combination option of different parts,
surfaces and colours.
senator® magic flow G2 refill (1.0 mm),
ink colour: blue or black

SERVICES

PMS Service: from 10,000 pieces,
see page 11
Additional refill option:
senator® magic flow G2 refill (1.4 mm),
see page 110

COLOURS

Barrel, clip, tip		Tip					
clear, polished		optional metal					
Clear/White	Cool Gray 9	445	Black	7408	151	186	201
Rhod. Red	267	Cyan	2935	2757	376	347	

BRANDING / AREA

A_1 Screen print	30 x 15 mm	C_3 Tampo print	40 x 2 mm
A_2 Screen print	40 x 12 mm	C_4 Tampo print	30 x 3 mm
C_1 Tampo print	45 x 5 mm	D Barrel print 360°	45 x 34 mm
C_2 Tampo print	35 x 8 mm	E_1 HD print 360° on white barrel	55 x 34 mm
		E_2 HD print 360° XL on white barrel	65 x 34 mm

PLASTIC PENS
METAL PENS
MUGS
SERVICES

LIBERTY® Clear

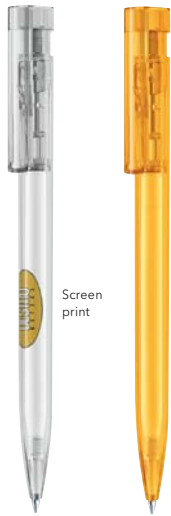

2983 2983

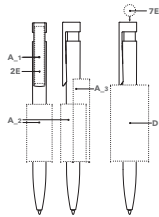

ART. NO. 2983

Push ball pen
Glossy transparent body and clip surface,
senator® magic flow G2 refill (1.0 mm)
ink colour: blue or black

SERVICES

5,000 in 5, see page 9
PMS Service: from 20,000 pieces,
see page 11

COLOURS



BRANDING / AREA

A_1	Screen print	40 x 6 mm	D	Barrel print 360°	60 x 30 mm
A_2	Screen print	45 x 20 mm	2E	Digital clip print	45 x 7 mm
A_3	Screen print	65 x 13 mm	7E	Digital cap print	Ø 9,5 mm

LIBERTY® Clear MC



2984 2984

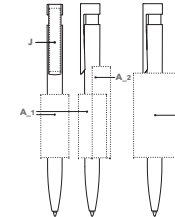

Laser engraving

ART. NO. 2984

Push ball pen
Glossy transparent body surface, metal clip,
senator® magic flow G2 refill (1.0 mm)
ink colour: blue or black

SERVICES

PMS Service: from 20,000 pieces, see page 11

COLOURS

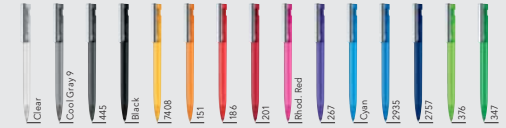

BRANDING / AREA

A_1	Screen print	45 x 20 mm	D	Barrel print 360°	60 x 30 mm
A_2	Screen print	65 x 13 mm	J	Laser engraving	45 x 6 mm

LIBERTY® Clear MTT



2982 2982

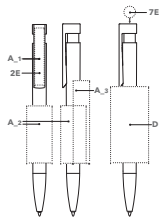

ART. NO. 2982

Push ball pen
Glossy transparent body and clip surface,
metallised tip,
senator® magic flow G2 refill (1.0 mm)
ink colour: blue or black

SERVICES

PMS Service: from 20,000 pieces, see page 11

COLOURS



BRANDING / AREA

A_1	Screen print	40 x 6 mm	D	Barrel print 360°	60 x 30 mm
A_2	Screen print	45 x 20 mm	2E	Digital clip print	45 x 7 mm
A_3	Screen print	65 x 13 mm	7E	Digital cap print	Ø 9,5 mm

LIBERTY® Clear MTT MC



2985 2985

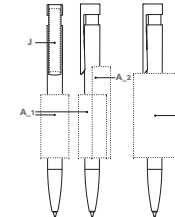

Screen print

ART. NO. 2985

Push ball pen
Glossy transparent body surface,
metallised tip, metal clip,
senator® magic flow G2 refill (1.0 mm)
ink colour: blue or black

SERVICES

PMS Service: from 20,000 pieces, see page 11

COLOURS



BRANDING / AREA

A_1	Screen print	45 x 20 mm	D	Barrel print 360°	60 x 30 mm
A_2	Screen print	65 x 13 mm	J	Laser engraving	45 x 6 mm

LIBERTY® Clear SG

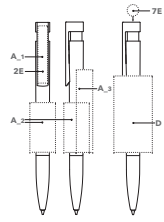
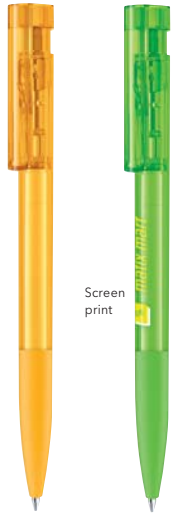

ART. NO. 3211

Push ball pen
Glossy transparent body and clip surface,
coloured soft grip zone matching the barrel,
senator® magic flow G2 refill (1.0 mm)
ink colour: blue or black

SERVICES

5,000 in 5, see page 9
PMS Service: from 20,000 pieces, see page 11

COLOURS



BRANDING / AREA

A_1	Screen print	40 x 6 mm	D	Barrel print 360°	60 x 30 mm
A_2	Screen print	39 x 20 mm	2E	Digital clip print	45 x 7 mm
A_3	Screen print	65 x 13 mm	7E	Digital cap print	Ø 9,5 mm

LIBERTY® Polished

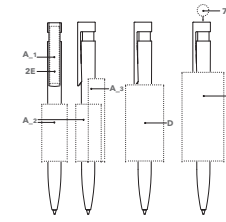
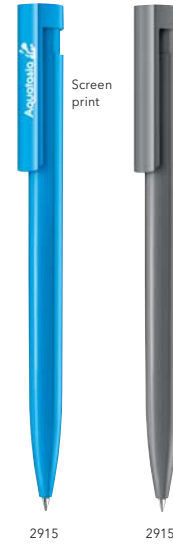

ART. NO. 2915

Push ball pen
Glossy opaque body and clip surface,
senator® magic flow G2 refill (1.0 mm)
ink colour: blue or black

SERVICES

5,000 in 5, see page 9
PMS Service: from 20,000 pieces,
see page 11

COLOURS

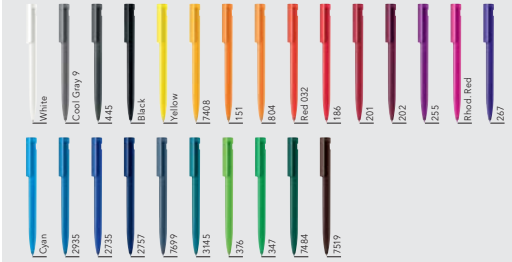

BRANDING / AREA

A_1	Screen print	40 x 6 mm	D	Barrel print 360°	60 x 30 mm
A_2	Screen print	45 x 20 mm	E	HD print 360° on white barrel	70 x 33 mm
A_3	Screen print	65 x 13 mm	2E	Digital clip print	45 x 7 mm
			7E	Digital cap print	Ø 9,5 mm

LIBERTY® Clear SG MC

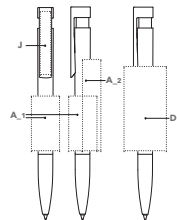

ART. NO. 3212

Push ball pen
Glossy transparent body and clip surface,
coloured soft grip zone matching the barrel,
metal clip,
senator® magic flow G2 refill (1.0 mm)
ink colour: blue or black

SERVICES

PMS Service: from 20,000 pieces, see page 11

COLOURS



BRANDING / AREA

A_1	Screen print	39 x 20 mm	D	Barrel print 360°	60 x 30 mm
A_2	Screen print	65 x 13 mm	J	Laser engraving	45 x 6 mm

LIBERTY® Polished MTT

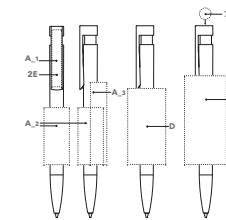
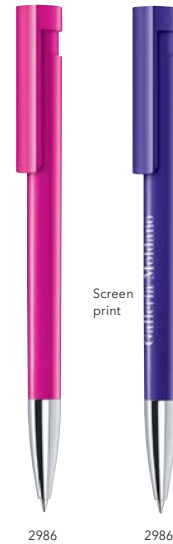

ART. NO. 2986

Push ball pen
Glossy opaque body and clip surface,
metalised tip,
senator® magic flow G2 refill (1.0 mm)
ink colour: blue or black

SERVICES

PMS Service: from 20,000 pieces, see page 11

COLOURS

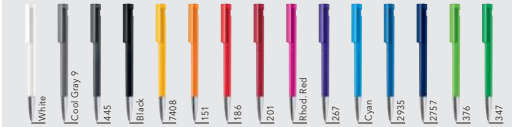

BRANDING / AREA

A_1	Screen print	40 x 6 mm	D	Barrel print 360°	60 x 30 mm
A_2	Screen print	45 x 20 mm	E	HD print 360° on white barrel	70 x 33 mm
A_3	Screen print	65 x 13 mm	2E	Digital clip print	45 x 7 mm
			7E	Digital cap print	Ø 9,5 mm

LIBERTY® Polished MC

MADE
BY
GERMANY

HD
PRINT

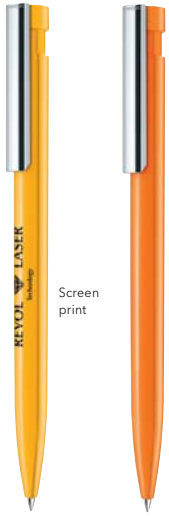

Screen
print

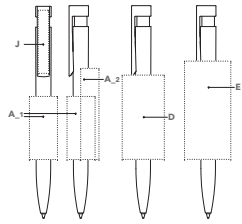

2916

2916

ART. NO. 2916

Push ball pen
Glossy opaque body surface, metal clip,
senator® magic flow G2 refill (1.0 mm)
ink colour: blue or black

SERVICES

PMS Service: from 20,000 pieces, see page 11

COLOURS



BRANDING / AREA

A_1	Screen print	45 x 20 mm	E	HD print 360° on white barrel	70 x 33 mm
A_2	Screen print	65 x 13 mm	J	Laser engraving	45 x 6 mm
D	Barrel print 360°	60 x 30 mm			

LIBERTY® Polished Basic

MADE
BY
GERMANY

5000
IN 5

HD
PRINT



Screen
print

HD
print

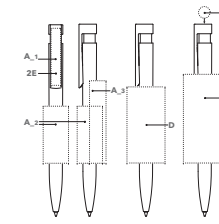

2993

2993

ART. NO. 2993

Push ball pen
Glossy opaque body and clip surface, white
barrel, coloured transparent mid part,
senator® magic flow G2 refill (1.0 mm)
ink colour: blue or black

SERVICES

5,000 in 5, see page 9
PMS Service: from 20,000 pieces, see page 11

COLOURS

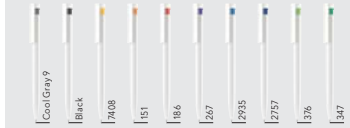

BRANDING / AREA

A_1	Screen print	40 x 6 mm	D	Barrel print 360°	60 x 30 mm
A_2	Screen print	45 x 20 mm	E	HD print 360°	70 x 33 mm
A_3	Screen print	65 x 13 mm	2E	Digital clip print	45 x 7 mm
			7E	Digital cap print	Ø 9,5 mm

LIBERTY® Polished MTT MC

MADE
BY
GERMANY

HD
PRINT

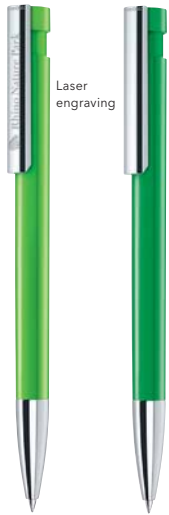

Laser
engraving

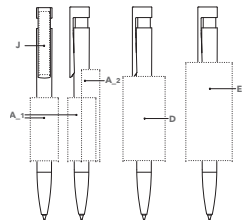

2917

2917

ART. NO. 2917

Push ball pen
Glossy opaque body surface, metallised tip,
metal clip,
senator® magic flow G2 refill (1.0 mm)
ink colour: blue or black

SERVICES

PMS Service: from 20,000 pieces, see page 11

COLOURS



BRANDING / AREA

A_1	Screen print	45 x 20 mm	E	HD print 360° on white barrel	70 x 33 mm
A_2	Screen print	65 x 13 mm	J	Laser engraving	45 x 6 mm
D	Barrel print 360°	60 x 30 mm			

LIBERTY® Polished Basic SG

MADE
BY
GERMANY

HD
PRINT



Screen
print

HD
print

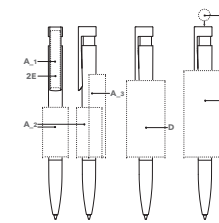

3210

3210

ART. NO. 3210

Push ball pen
Glossy opaque body and clip surface, white
barrel, coloured soft-grip zone matching
the mid part,
senator® magic flow G2 refill (1.0 mm)
ink colour: blue or black

SERVICES

PMS Service: from 20,000 pieces, see page 11

COLOURS

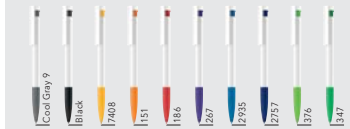

BRANDING / AREA

A_1	Screen print	40 x 6 mm	D	Barrel print 360°	60 x 30 mm
A_2	Screen print	39 x 20 mm	E	HD print 360°	68 x 33 mm
A_3	Screen print	65 x 13 mm	2E	Digital clip print	45 x 7 mm
			7E	Digital cap print	Ø 9,5 mm

LIBERTY® Polished Basic SG MC

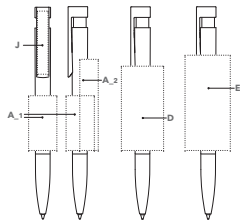

ART. NO. 3213

Push ball pen
Glossy opaque body and clip surface, white barrel, coloured soft grip zone matching the mid part, metal clip,
senator® magic flow G2 refill (1.0 mm)
ink colour: blue or black

SERVICES

PMS Service: from 20,000 pieces, see page 11

COLOURS

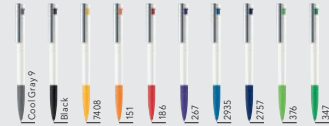

BRANDING / AREA

A_1	Screen print	39 x 20 mm	E	HD print 360°	68 x 33 mm
A_2	Screen print	65 x 13 mm	J	Laser engraving	45 x 6 mm
D	Barrel print 360°	60 x 30 mm			

LIBERTY® Soft Touch

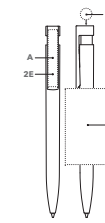

ART. NO. 2015

Push ball pen
Velvety body surface, glossy transparent mid and clip surface,
senator® magic flow G2 refill (1.0 mm)
ink colour: blue or black

SERVICES

PMS Service: from 20,000 pieces, see page 11

COLOURS



BRANDING / AREA

A	Screen print	40 x 6 mm	2E	Digital clip print	45 x 7 mm
D	Barrel print 360°	60 x 30 mm	7E	Digital cap print	Ø 9.5 mm

LIBERTY® Soft Touch MC

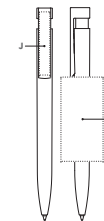

ART. NO. 2942

Push ball pen
Velvety body surface, glossy transparent mid and clip holder, metal clip,
senator® magic flow G2 refill (1.0 mm)
ink colour: blue or black

SERVICES

PMS Service: from 20,000 pieces, see page 11

COLOURS



BRANDING / AREA

D	Barrel print 360°	60 x 30 mm	J	Laser engraving	45 x 6 mm
---	-------------------	------------	---	-----------------	-----------



LIBERTY SOFT TOUCH

STANDING OUT NEVER FELT SO GOOD.

Pleasantly soft and classy. The senator® soft touch surface adds something special to the Liberty ball pen.

LIBERTY® Mix & Match

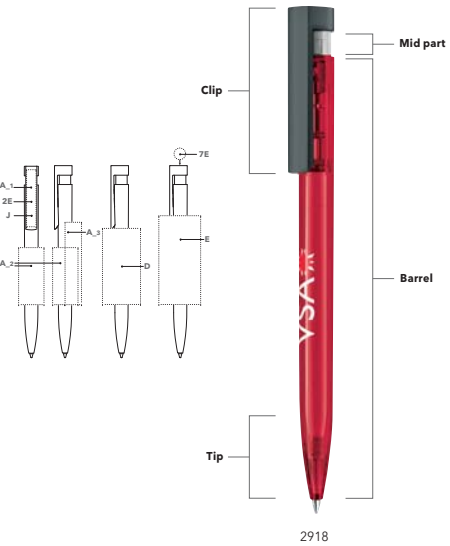

2918

ART. NO. 2918

Push ball pen
Free combination option of different parts (barrel, mid, clip), surfaces (clear or polished), accessories (metallised tip or metal clip) and colours,
senator® magic flow G2 refill (1.0 mm)
ink colour: blue or black

SERVICES

PMS Service: from 20,000 pieces,
see page 11

Additional refill option:
senator® magic flow refill G2 1.4, see page 110

COLOURS

Barrel		Clip, mid part		Clip metal		Barrel with metallised tip	
clear, polished, softtouch		clear, polished		with clip holder clear, polished		clear, polished	
Clear/White	Cool Gray 9	445	Black	Yellow	7408	151	804
Red 032	186	201	202	255	Rhod. Red	267	Cyan
2935	2735	2757	7699	3145	376	347	7484
7519							

BRANDING / AREA 2918

A_1	Screen print	40 x 6 mm	E	HD print 360°	70 x 33 mm
A_2	Screen print	45 x 20 mm	2E	Digital clip print	45 x 7 mm
A_3	Screen print	65 x 13 mm	7E	Digital cap print	Ø 9,5 mm
D	Barrel print 360°	60 x 30 mm	J	Metal clip:	45 x 6 mm
				Lasere engraving	

BRANDING / AREA 2829

A	Screen print	40 x 6 mm	7E	Digital cap print	Ø 9,5 mm
D	Barrel print 360°	60 x 30 mm	J	Metal clip:	45 x 6 mm
2E	Digital clip print	45 x 7 mm		Lasere engraving	
	(not on metal clip)				

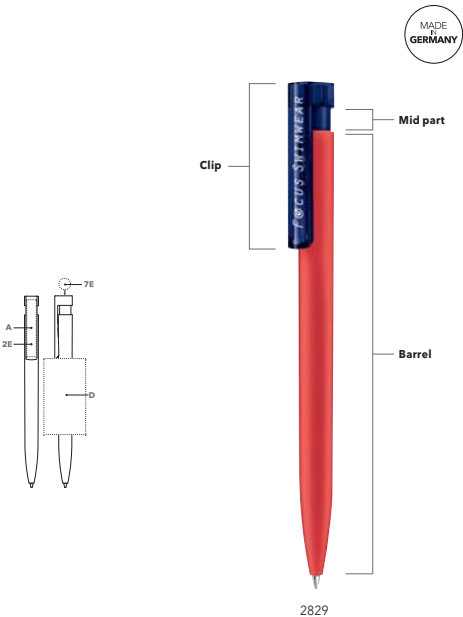

2829

LIBERTY® Clip4U

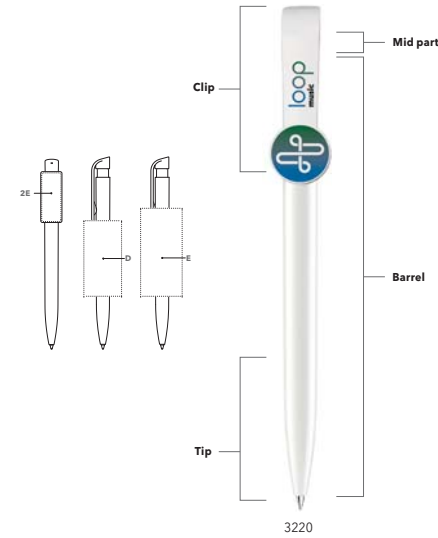

3220

ART. NO. 3220

Push ball pen
with individual clip shape

Design your own clip shape or choose your favourite from available ones. Free combination option of different parts, surfaces and accessories.
senator® magic flow G2 refill (1.0 mm)
Ink colour: blue or black

SERVICES

PMS Service: from 20,000 pieces,
see page 11

Additional refill option:
senator® magic flow refill G2 1.4,
see page 110

COLOUR

Barrel, clip, mid part
clear, polished

Clear/White	Cool Gray 9	445	Black	Yellow	7408	151	804
Red 032	186	201	202	255	Rhod. Red	267	Cyan
2935	2735	2757	7699	3145	376	347	7484
7519							

Barrel with metallised tip
clear, polished

White	Cool Gray 9	445	Black	7408	151	186	201
Rhod. Red	267	Cyan	2935	2757	376	347	

Barrel with soft grip zone
white barrel, coloured grip zone or clear barrel, grip zone same colour

Black	7408	151	186	267	2935	2757	376
347							

For these clip shapes we do not charge any tooling costs.

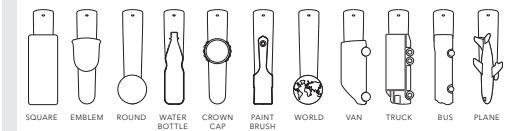

BRANDING / AREA

D	Barrel print 360°	60 x 30 mm	2E	Digital clip print	max. 40.5 x 16 mm
E	HD print 360°	70 x 33 mm		on white barrel	(depending on clip shape)



YOUR INDIVIDUAL CLIP SHAPE

ENDLESS COMBINATION POSSIBILITIES

VARIOUS BRANDING POSSIBILITIES ON CLIP AND BARREL

Design your own clip shape. Contact us for more information.





CHALLENGER

**UNRIVALLED
QUALITY
AND
LONGEVITY.**

Always a good choice. The incomparable variety of combination possibilities colour and surface combinations make the senator® Challenger one of the most favourite ball pen models.

**CHALLENGER
Clear**



2192

2192

Screen print

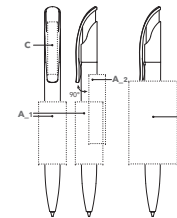

ART. NO. 2192

Push ball pen
Glossy transparent body and clip surface,
senator® magic flow G2 refill (1.0 mm)
ink colour: blue or black

SERVICES

5,000 in 5, see page 9
PMS Service: from 20,000 pieces, see page 11

COLOURS

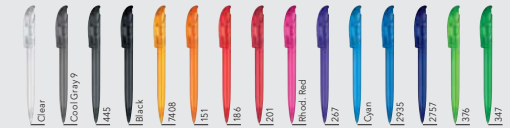

BRANDING / AREA

A_1 Screen print	45 x 20 mm	C Tampo print	35 x 7 mm or 40 x 5 mm
A_2 Screen print	50 x 12 mm	D Barrel print 360°	60 x 35 mm

**CHALLENGER
Clear MT**



2925

2925

Tampo print

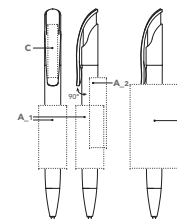

ART. NO. 2925

Push ball pen
Glossy transparent body and clip surface,
glossy metal tip,
senator® magic flow G2 refill (1.0 mm)
ink colour: blue or black

SERVICES

PMS Service: from 20,000 pieces, see page 11

COLOURS



BRANDING / AREA

A_1 Screen print	45 x 20 mm	C Tampo print	35 x 7 mm or 40 x 5 mm
A_2 Screen print	50 x 12 mm	D Barrel print 360°	60 x 35 mm

CHALLENGER Clear SG

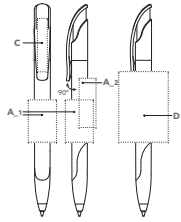
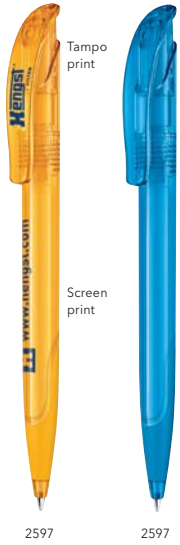

ART. NO. 2597

Push ball pen
Glossy transparent body and clip surface,
coloured soft grip zone matching the barrel,
senator® magic flow G2 refill (1.0 mm)
ink colour: blue or black

SERVICES

5,000 in 5, see page 9
PMS Service: from 20,000 pieces, see page 11

COLOURS

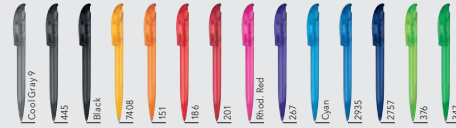

BRANDING / AREA

A_1 Screen print	30 x 20 mm or 45 x 10 mm	C Tampo print	35 x 7 mm or 40 x 5 mm
A_2 Screen print	35 x 12 mm	D Barrel print 360°	60 x 35 mm

CHALLENGER Polished

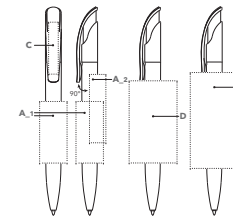
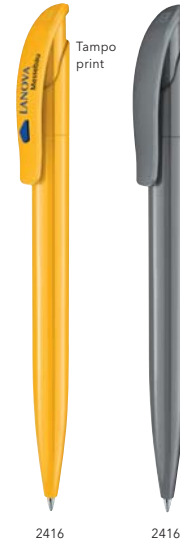

ART. NO. 2416

Push ball pen
Glossy opaque body and clip surface,
senator® magic flow G2 refill (1.0 mm)
ink colour: blue or black

SERVICES

5,000 in 5, see page 9
PMS Service: from 20,000 pieces, see page 11

COLOURS



BRANDING / AREA

A_1 Screen print	45 x 20 mm	D Barrel print 360°	60 x 35 mm
A_2 Screen print	50 x 12 mm	E HD print 360° on white barrel	70 x 35 mm
C Tampo print	35 x 7 mm or 40 x 5 mm		

CHALLENGER Frosted

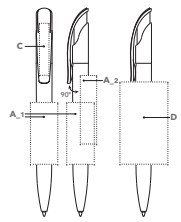

ART. NO. 2418

Push ball pen
Translucent shine-free body and clip
surface,
senator® magic flow G2 refill (1.0 mm)
ink colour: blue or black

SERVICES

5,000 in 5, see page 9
Pen Express, see page 9
PMS Service: from 20,000 pieces, see page 11

COLOURS

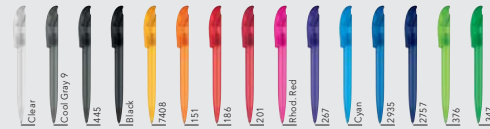

BRANDING / AREA

A_1 Screen print	45 x 20 mm	C Tampo print	35 x 7 mm or 40 x 5 mm
A_2 Screen print	50 x 12 mm	D Barrel print 360°	60 x 35 mm

CHALLENGER Polished MT

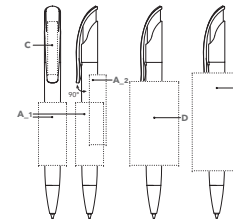

ART. NO. 2926

Push ball pen
Glossy opaque body and clip surface,
glossy metal tip,
senator® magic flow G2 refill (1.0 mm)
ink colour: blue or black

SERVICES

PMS Service: from 20,000 pieces, see page 11

COLOURS



BRANDING / AREA

A_1 Screen print	45 x 20 mm	D Barrel print 360°	60 x 35 mm
A_2 Screen print	50 x 12 mm	E HD print 360° on white barrel	70 x 35 mm
C Tampo print	35 x 7 mm or 40 x 5 mm		

CHALLENGER

Polished Basic

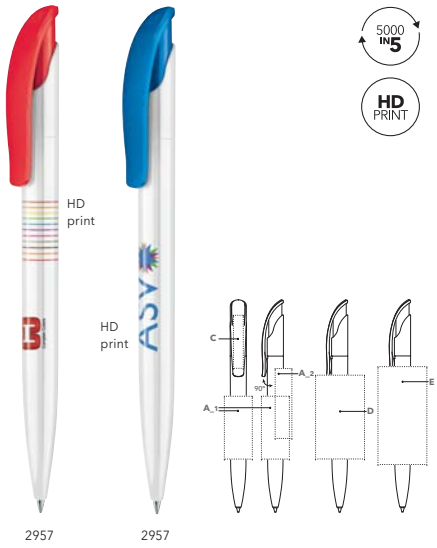

MADE IN GERMANY

5000 IN 5

HD PRINT

ART. NO. 2957

Push ball pen
Glossy opaque body and clip surface, white barrel, coloured clip, senator® magic flow G2 refill (1.0 mm) ink colour: blue or black

SERVICES

5,000 in 5, see page 9
PMS Service: from 20,000 pieces, see page 11

COLOURS



BRANDING / AREA

A_1	Screen print	45 x 20 mm	D	Barrel print 360°	60 x 35 mm
A_2	Screen print	50 x 12 mm	E	HD print 360°	70 x 35 mm
C	Tampo print	35 x 7 mm or 40 x 5 mm			

CHALLENGER

Soft Touch



MADE IN GERMANY

ART. NO. 2737

Push ball pen
Velvety surface, transparent clip, senator® magic flow G2 refill (1.0 mm) ink colour: blue or black

SERVICES

PMS Service: from 20,000 pieces, see page 11

COLOURS



BRANDING / AREA

C	Tampo print	35 x 7 mm or 40 x 5 mm	D	Barrel print 360°	60 x 35 mm
---	-------------	------------------------	---	-------------------	------------

CHALLENGER

Polished Basic SG



MADE IN GERMANY

HD PRINT

ART. NO. 2958

Push ball pen
Glossy opaque body and clip surface, white barrel, coloured clip and soft grip zone, senator® magic flow G2 refill (1.0 mm) ink colour: blue or black

SERVICES

PMS Service: from 20,000 pieces, see page 11

COLOURS



BRANDING / AREA

A_1	Screen print	30 x 20 mm or 45 x 10 mm	D	Barrel print 360°	50 x 35 mm
A_2	Screen print	35 x 12 mm	E	HD print 360°	60 x 35 mm
C	Tampo print	35 x 7 mm or 40 x 5 mm			

CHALLENGER

Mix & Match

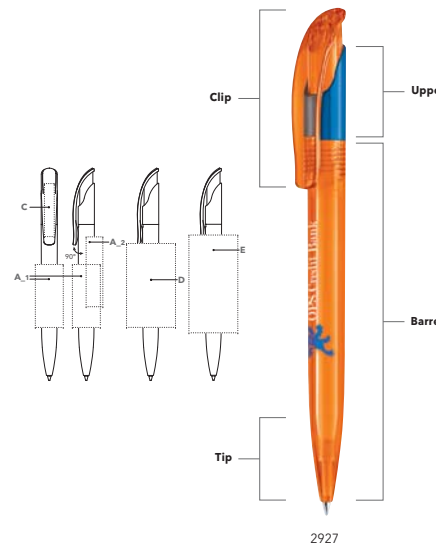

MADE IN GERMANY

HD PRINT

ART. NO. 2927

Push ball pen
Free combination option of different parts (barrel, upper, clip), surfaces (clear, polished, frosted), accessories and colours, senator® magic flow G2 refill (1.0 mm) ink colour: blue or black

SERVICES

PMS Service: from 20,000 pieces, see page 11
Additional refill option: senator® magic flow refill G2 1.4, see page 110

COLOURS

Barrel, clip, upper		Barrel with metal tip	
clear, polished, frosted		clear	
Clear/White	Cool Gray 9	445	Black
		7408	151
		186	201
Rhod. Red	267	Cyan	2935
		2757	376
			347

Barrel with metal tip

polished	
White	Black

BRANDING / AREA

A_1	Screen print	45 x 20 mm	D	Barrel print 360°	60 x 35 mm
A_2	Screen print	50 x 12 mm	E	HD print 360° on polished white barrel	70 x 35 mm
C	Tampo print	35 x 7 mm or 40 x 5 mm			

SUPER HIT Clear

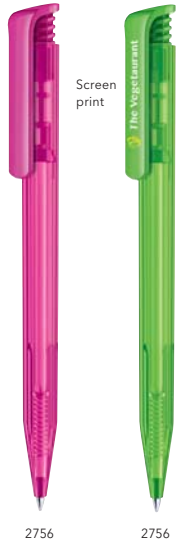

MADE IN GERMANY

5000 IN 5

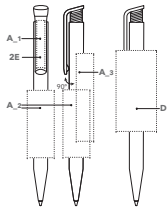

ART. NO. 2756

Push ball pen
Glossy transparent body surface and shiny opaque clip pusher, senator® magic flow X20 refill (1.0 mm) ink colour: blue or black

SERVICES

5,000 in 5, see page 9
PMS Service: from 20,000 pieces, see page 11

COLOURS



BRANDING / AREA

A_1 Screen print	35 x 6 mm	D Barrel print 360°	60 x 30 mm
A_2 Screen print	50 x 20 mm	2E Digital clip print	37 x 7 mm
A_3 Screen print	65 x 13 mm		

SUPER HIT Frosted



MADE IN GERMANY

5000 IN 5

PEN EXPRESS

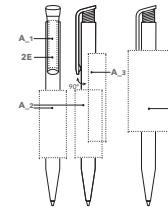

ART. NO. 2244

Push ball pen
Translucent shine-free body surface, glossy opaque clip pusher, senator® magic flow X20 refill (1.0 mm) ink colour: blue or black

SERVICES

5,000 in 5, see page 9
Pen Express, see page 9
PMS Service: from 20,000 pieces, see page 11

COLOURS



BRANDING / AREA

A_1 Screen print	35 x 6 mm	D Barrel print 360°	60 x 30 mm
A_2 Screen print	50 x 20 mm	2E Digital clip print	37 x 7 mm
A_3 Screen print	65 x 13 mm		

SUPER HIT Clear SG

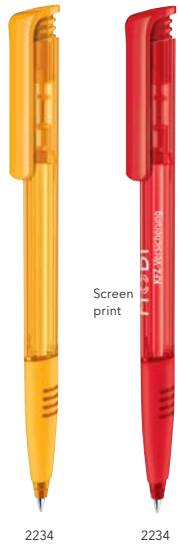

MADE IN GERMANY

5000 IN 5

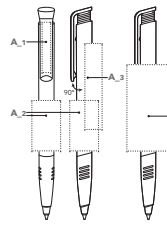

ART. NO. 2234

Push ball pen
Glossy transparent body surface and shiny opaque clip pusher, coloured soft grip zone, senator® magic flow X20 refill (1.0 mm) ink colour: blue or black

SERVICES

5,000 in 5, see page 9
PMS Service: from 20,000 pieces, see page 11

COLOURS

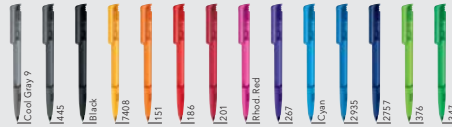

BRANDING / AREA

A_1 Screen print	35 x 6 mm	D Barrel print 360°	60 x 30 mm
A_2 Screen print	35 x 20 mm		
A_3 Screen print	60 x 12 mm		

SUPER HIT Matt



MADE IN GERMANY

5000 IN 5

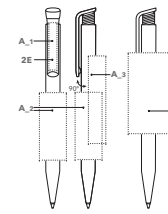

ART. NO. 2904

Push ball pen
Opaque, shine-free finish body surface, glossy opaque clip pusher, senator® magic flow X20 refill (1.0 mm) ink colour: blue or black

SERVICES

5,000 in 5, see page 9
PMS Service: from 20,000 pieces, see page 11

COLOURS



BRANDING / AREA

A_1 Screen print	35 x 6 mm	D Barrel print 360°	60 x 30 mm
A_2 Screen print	50 x 20 mm	2E Digital clip print	37 x 7 mm
A_3 Screen print	65 x 13 mm		

SUPER HIT Polished

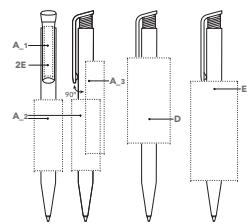

- MADE IN GERMANY
- 5000 IN 5
- PEN EXPRESS
- HD PRINT

ART. NO. 2883
Push ball pen
Glossy opaque body and clip surface,
senator® magic flow X20 refill (1.0 mm)
ink colour: blue or black

SERVICES
5,000 in 5, see page 9
Pen Express, see page 9
PMS Service: from 20,000 pieces, see page 11



BRANDING / AREA

A_1 Screen print	35 x 6 mm	D Barrel print 360°	60 x 30 mm
A_2 Screen print	50 x 20 mm	E HD print 360° on white barrel	70 x 33 mm
A_3 Screen print	65 x 13 mm	2E Digital clip print	37 x 7 mm

SUPER HIT Polished Basic SG

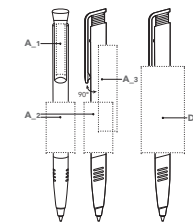

- MADE IN GERMANY

ART. NO. 2956
Push ball pen
Polished opaque body and clip surface, white
barrel, coloured clip and soft grip zone,
senator® magic flow X20 refill (1.0 mm)
ink colour: blue or black

SERVICES
PMS Service: from 20,000 pieces, see page 11

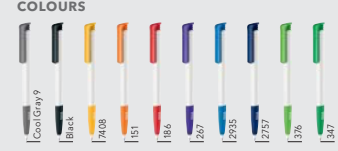

BRANDING / AREA

A_1 Screen print	35 x 6 mm	D Barrel print 360°	60 x 30 mm
A_2 Screen print	35 x 20 mm		
A_3 Screen print	60 x 12 mm		

SUPER HIT Polished Basic

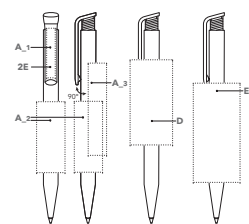
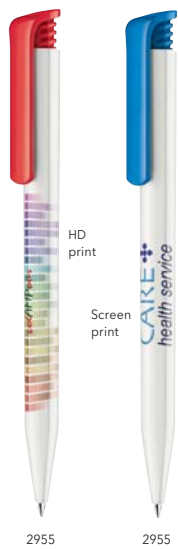

- MADE IN GERMANY
- 5000 IN 5
- PEN EXPRESS
- HD PRINT

ART. NO. 2955
Push ball pen
Polished opaque body and clip surface,
white barrel, coloured clip,
senator® magic flow X20 refill (1.0 mm)
ink colour: blue or black

SERVICES
5,000 in 5, see page 9
Pen Express, see page 9
PMS Service: from 20,000 pieces, see page 11

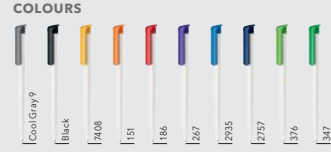

BRANDING / AREA

A_1 Screen print	35 x 6 mm	D Barrel print 360°	60 x 30 mm
A_2 Screen print	50 x 20 mm	E HD print 360°	70 x 33 mm
A_3 Screen print	65 x 13 mm	2E Digital clip print	37 x 7 mm

SUPER HIT Recycled

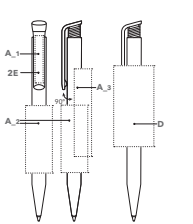

- MADE IN GERMANY

ART. NO. 2850
Push ball pen
Polished opaque body and clip surface,
black barrel made of 95% recycled material,
coloured clip
senator® magic flow X20 refill (1.0 mm)
ink colour: blue or black

SERVICES
PMS Service (Clip): from 20,000 pieces,
see page 11



BRANDING / AREA

A_1 Screen print	35 x 6 mm	D Barrel print 360°	60 x 30 mm
A_2 Screen print	50 x 20 mm	2E Digital clip print	37 x 7 mm
A_3 Screen print	65 x 13 mm		

SUPER HIT Mix & Match

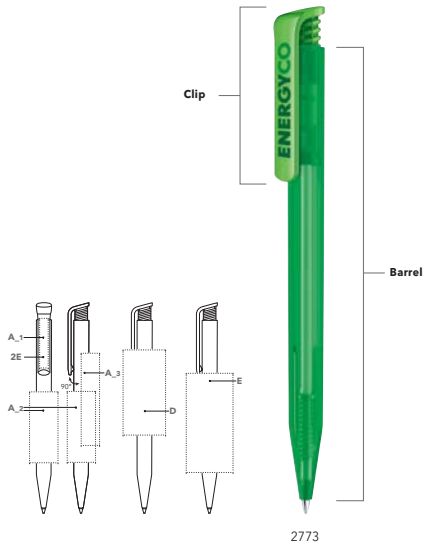

ART. NO. 2773

Push ball pen
Free combination option of different parts (barrel and clip), surfaces (clear, polished, frosted, matt) and colours, senator® magic flow X20 refill (1.0 mm) ink colour: blue or black

COLOURS

Clip	Barrel						
polished	clear, polished, frosted, matt						
Clear/White	Cool Gray 9	445	Black	7408	151	186	201
Rhod. Red	267	Cyan	2935	2757	376	347	

BRANDING / AREA

A_1	Screen print	35 x 6 mm	D	Barrel print 360°	60 x 30 mm
A_2	Screen print	50 x 20 mm	E	HD print 360° on polished white barrel	70 x 33 mm
A_3	Screen print	65 x 13 mm	2E	Digital clip print	37 x 7 mm

SERVICES

PMS Service: from 20,000 pieces, see page 11

DART Polished



ART. NO. 2600

Push ball pen
Glossy opaque body and clip surface, senator® magic flow X20 refill (1.0 mm) ink colour: blue or black

SERVICES

5,000 in 5, see page 9
Pen Express, see page 9
PMS Service: from 20,000 pieces, see page 11

COLOURS



BRANDING / AREA

A_1	Screen print	30 x 4 mm or 25 x 5 mm or 20 x 6 mm	A_2	Screen print	35 x 20 mm
A_3	Screen print	65 x 12 mm			

DART Clear

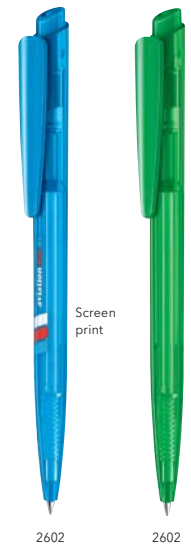

ART. NO. 2602

Push ball pen
Glossy transparent body surface, glossy opaque clip pusher, senator® magic flow X20 refill (1.0 mm) ink colour: blue or black

SERVICES

5,000 in 5, see page 9
PMS Service: from 20,000 pieces, see page 11

COLOURS

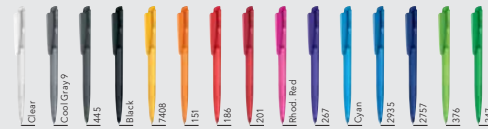

BRANDING / AREA

A_1	Screen print	30 x 4 mm or 25 x 5 mm or 20 x 6 mm	A_2	Screen print	35 x 20 mm
A_3	Screen print	65 x 12 mm			

DART Polished Basic



ART. NO. 2959

Push ball pen
Glossy opaque body and clip surface, white barrel, coloured clip pusher, senator® magic flow X20 refill (1.0 mm) ink colour: blue or black

SERVICES

5,000 in 5, see page 9
Pen Express, see page 9
PMS Service: from 20,000 pieces, see page 11

COLOURS

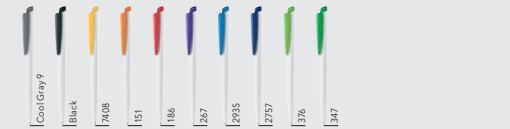

BRANDING / AREA

A_1	Screen print	30 x 4 mm or 25 x 5 mm or 20 x 6 mm	A_2	Screen print	35 x 20 mm
A_3	Screen print	65 x 12 mm			

POINT Polished

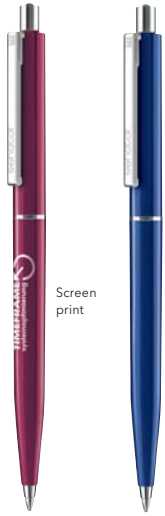

Screen print

3217

3217

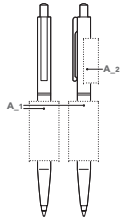

ART. NO. 3217

Push ball pen
Glossy opaque body surface, metal fittings,
push-button with plastic inlay
senator® magic flow X20 refill (1.0 mm)
ink colour: blue or black

SERVICES

PMS Service: from 20,000 pieces, see page 11

COLOURS



BRANDING / AREA

A_1	Screen print	40 x 20 mm
A_2	Screen print	30 x 10 mm

POINT Metal



Laser engraving

Screen print

2866

2866

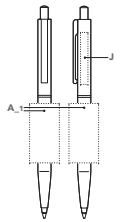

ART. NO. 2866

Push ball pen
Polished opaque body surface, metal
upper part, metal fittings, push-button with
plastic inlay
senator® metal refill G2
ink colour: blue

SERVICES

PMS Service: from 30,000 pieces, see page 11

COLOURS

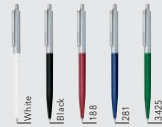

BRANDING / AREA

A_1	Screen print	40 x 20 mm	J	Laser engraving	35 x 5 mm
-----	--------------	------------	---	-----------------	-----------

HATTRIX Clear SG



Screen print

2339

2339

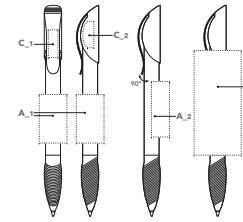

ART. NO. 2339

Push ball pen
Glossy transparent body surface, upper part
and clip polished, coloured soft grip
senator® magic flow G2 refill (1.0 mm)
ink colour: blue or black

SERVICES

PMS Service: from 20,000 pieces, see page 11

COLOURS



BRANDING / AREA

A_1	Screen print	35 x 20 mm	C_1	Tampo print	20 x 7 mm
A_2	Screen print	40 x 13 mm	C_2	Tampo print	10 x 7 mm or 19 x 4 mm 1 colour
			D	Barrel print 360°	75 x 33.9 mm

HATTRIX Clear SG MC



Screen print

2419

2419

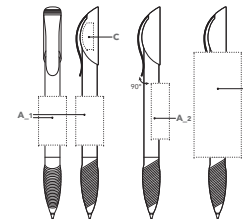

ART. NO. 2419

Push ball pen
Glossy transparent body surface, upper part
polished, coloured soft grip zone fits with
the barrel, metal clip
senator® magic flow G2 refill (1.0 mm)
ink colour: blue or black

SERVICES

PMS Service: from 20,000 pieces, see page 11

COLOURS



BRANDING / AREA

A_1	Screen print	35 x 20 mm	C	Tampo print	10 x 7 mm or 19 x 4 mm 1 colour
A_2	Screen print	40 x 13 mm			
			D	Barrel print 360°	75 x 33.9 mm

HATTRIX Polished Basic

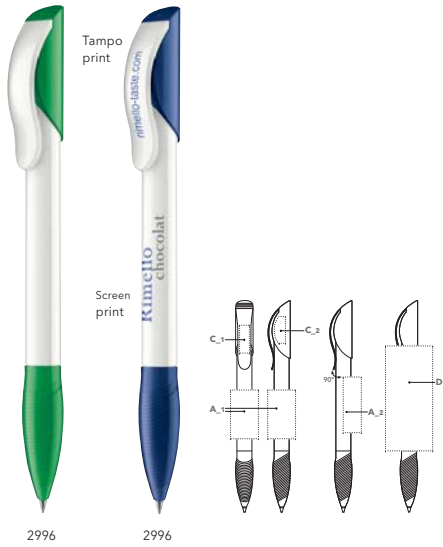

ART. NO. 2996

Push ball pen
Glossy opaque body and clip surface, white barrel and clip, coloured upper part, senator® magic flow G2 refill (1.0 mm)
ink colour: blue or black

SERVICES

PMS Service: from 20,000 pieces, see page 11

COLOURS



BRANDING / AREA

A_1	Screen print	35 x 20 mm	C_1	Tampon print	20 x 7 mm
A_2	Screen print	40 x 13 mm	C_2	Tampon print	10 x 7 mm or 19 x 4 mm 1 colour
			D	Barrel print 360°	75 x 33.9 mm

HATTRIX Polished Basic SG MC

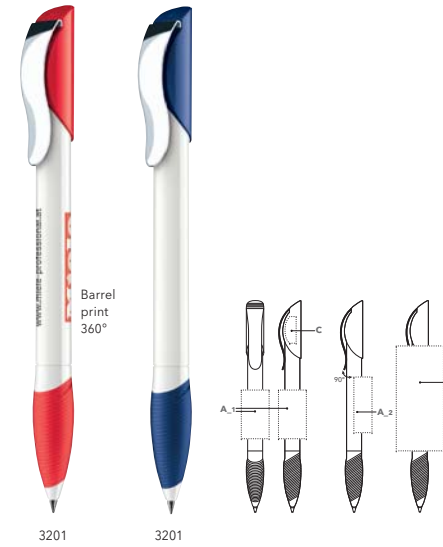

ART. NO. 3201

Push ball pen
Glossy opaque body and clip surface, white barrel, metal clip and coloured soft grip zone, senator® magic flow G2 refill (1.0 mm)
ink colour: blue or black

SERVICES

PMS Service: from 20,000 pieces, see page 11

COLOURS

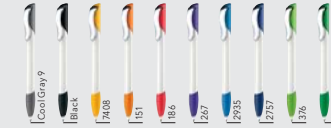

BRANDING / AREA

A_1	Screen print	35 x 20 mm	C	Tampon print	10 x 7 mm or 19 x 4 mm 1 colour
A_2	Screen print	40 x 13 mm	D	Barrel print 360°	75 x 33.9 mm

HATTRIX Polished Basic SG

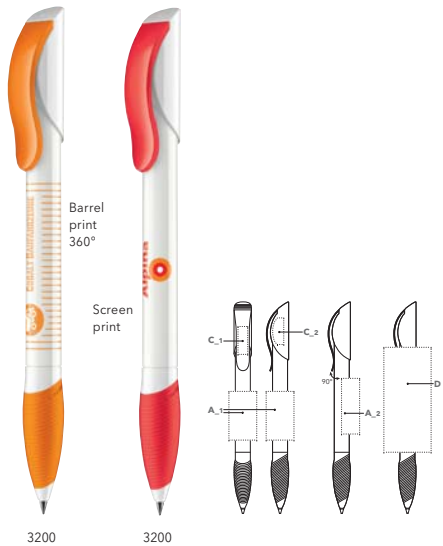

ART. NO. 3200

Push ball pen
Glossy opaque body and clip surface, white barrel, coloured clip and soft grip zone, senator® magic flow G2 refill (1.0 mm)
ink colour: blue or black

SERVICES

PMS Service: from 20,000 pieces, see page 11

COLOURS



BRANDING / AREA

A_1	Screen print	35 x 20 mm	C_1	Tampon print	20 x 7 mm
A_2	Screen print	40 x 13 mm	C_2	Tampon print	10 x 7 mm or 19 x 4 mm 1 colour
			D	Barrel print 360°	75 x 33.9 mm

HATTRIX Mix & Match

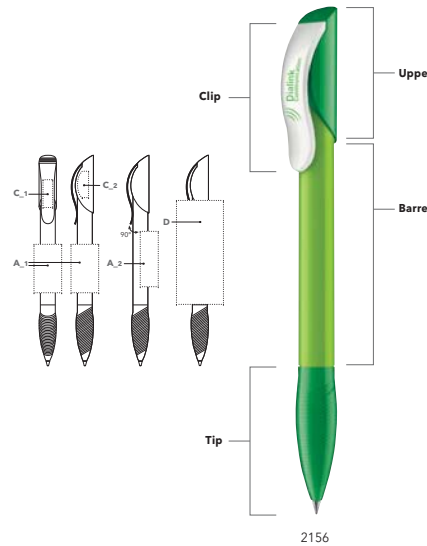

ART. NO. 2156

Push ball pen
Free combination option of different parts (barrel, tip, upper and clip), surfaces (polished and clear for barrel & tip, polished for clip and upper), accessories (metal clip) and colours, senator® magic flow G2 refill (1.0 mm), ink colour: blue or black

SERVICES

PMS Service: from 20,000 pieces, see page 11
Additional refill option: senator® magic flow refill G2 1.4, see page 110

COLOURS

Barrel polished	Clip/upper/tip polished	clip optional metal clip
White	Cool Gray 9 Black 7408 151 186 267 2935	
2757	376 347	
Barrel clear		
Cool Gray 9 Black 7408 151 186 267 2935 2757		
376 347		

BRANDING / AREA

A_1	Screen print	35 x 20 mm	C_2	Tampon print	10 x 7 mm or 19 x 4 mm 1 colour
A_2	Screen print	40 x 13 mm	D	Barrel print 360°	75 x 33.9 mm
C_1	Tampon print	20 x 7 mm			

CENTRIX® Mix & Match

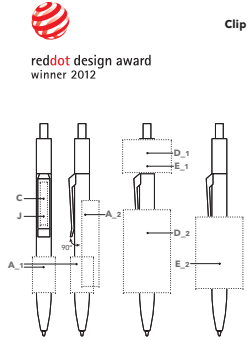

reddot design award
winner 2012

2708

ART. NO. 2708

Push ball pen
Free combination option of different parts
(barrel, upper, push-button and clip),
surfaces (polished and clear), accessories
(metal clip and metal springs) and colours,
senator® magic flow G2 refill (1.0 mm)
ink colour: blue or black

SERVICES

PMS Service: from 20,000 pieces,
see page 11

Additional refill option:
senator® magic flow refill G2 1.4,
see page 110

COLOURS

Barrel, clip, upper, push button		Clip	
clear, polished		optional metal	
Clear/White	Cool Gray 9 445	Black	7408 151 186 201
Rhod. Red	267	Cyan	2935 2757 376 347

BRANDING / AREA

A_1 Screen print	25 x 16 mm	D_2 Barrel print 360°	58 x 33 mm
A_2 Screen print	60 x 12 mm	E_1 HD print 360° on white barrel	24,5 x 34 mm
C Tampo print	30 x 5 mm	2E HD print 360° on white barrel	50 x 33 mm
D_1 Barrel print 360°	24 x 34 mm	J Metal clip: Laser engraving	30 x 5 mm

BIG PEN Polished Basic

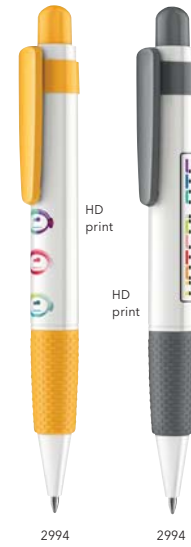

2994

2994

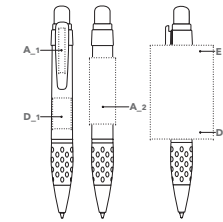

ART. NO. 2994

Push ball pen
White barrel with glossy opaque body
surface, soft grip zone, coloured opaque
clip and push clip,
X20 jumbo refill
ink colour: blue or black

SERVICES

PMS Service: from 30,000 pieces, see page 11

COLOURS



BRANDING / AREA

A_1 Screen print	29 x 4 mm	D_1 Barrel print 360°	20 x 12 mm
A_2 Screen print	43 x 17 mm	D_2 Barrel print 360°	61 x 40.9 mm
		E HD print 360°	61.6 x 41 mm

BIG PEN Mix & Match

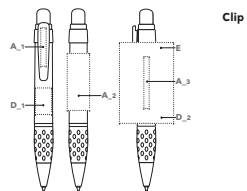

2774

ART. NO. 2774

Push ball pen
Free combination option of different parts,
surfaces and colours, X20 jumbo refill,
ink colour: blue or black

SERVICES

PMS Service: from 30,000 pieces,
see page 11

COLOURS

Barrel	Clip, push button	Tip	Barrel with window
polished, frosted	polished	polished	polished white
White	Cool Gray 9 445	Black	7408 151 186 202
Cyan	2935 2757 376 347		
Soft grip	frosted only in white		
polished			
Cool Gray 9 445	Black	7408	151 186 202 Cyan
2935 2757 376 347			

BRANDING / AREA

A_1 Screen print	29 x 4 mm	D_1 Barrel print 360°	20 x 12 mm
A_2 Screen print	43 x 17 mm	D_2 Barrel print 360°	61 x 40.9 mm
A_3 Screen print on text tube	6 lines, each 38 x 3 mm 1 colour	E HD print 360° on polished white barrel (not for barrel with window)	61.6 x 41 mm

BIG PEN Frosted



1177

1177

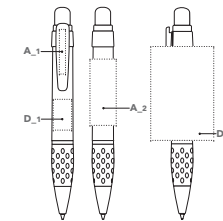

ART. NO. 1177

Push ball pen
Coloured frosted body surface, white
frosted clip, tip and push clip,
X20 jumbo refill
ink colour: blue or black

SERVICES

PMS Service: from 30,000 pieces, see page 11

COLOURS

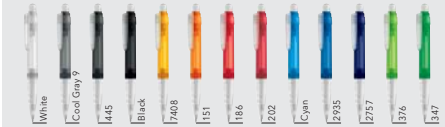

BRANDING / AREA

A_1 Screen print	29 x 4 mm	D_1 Barrel print 360°	20 x 12 mm
A_2 Screen print	43 x 17 mm	D_2 Barrel print 360°	61 x 40.9 mm

NATURE PLUS

BRAND AMBASSADOR MADE OF BIO PLASTIC.

Made from renewable resources, biodegradable and uniquely sustainable. Communicate your environmental awareness down to the last detail.



NATURE PLUS Matt

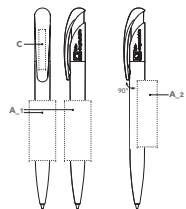
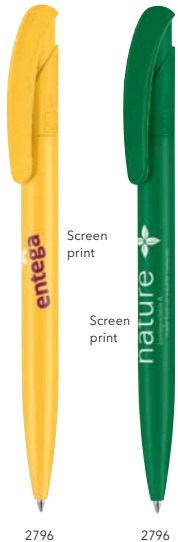

ART. NO. 2796

Push ball pen
Opaque, shine-free finish barrel and clip surface, biodegradable material, senator* magic flow G2 refill (1.0 mm) ink colour: blue or black

SERVICES

PMS Service: from 20,000 pieces, see page 11

COLOURS



BRANDING / AREA

A_1	Screen print	45 x 20 mm	C	Tampo print	30 x 5 mm
A_2	Screen print	50 x 15 mm			

NEW SPRING Clear

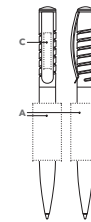
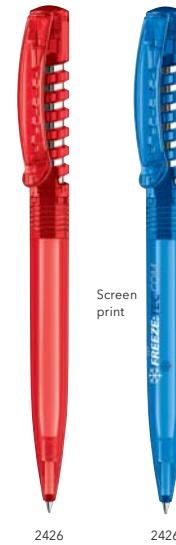

ART. NO. 2426

Push ball pen
Glossy transparent body and surface, metallised inner push-button, senator* magic flow G2 refill (1.0 mm) ink colour: blue or black

SERVICES

PMS Service: from 20,000 pieces, see page 11

COLOURS



BRANDING / AREA

A	Screen print	40 x 20 mm	C	Tampo print	25 x 5 mm
---	--------------	------------	---	-------------	-----------

NEW SPRING Clear MC

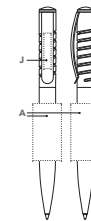

ART. NO. 2410

Push ball pen
Glossy transparent body surface, metallised inner push-button, metal clip, senator* magic flow G2 refill (1.0 mm) ink colour: blue or black

SERVICES

PMS Service: from 20,000 pieces, see page 11

COLOURS



BRANDING / AREA

A	Screen print	40 x 20 mm	J	Laser engraving	30 x 6 mm
---	--------------	------------	---	-----------------	-----------

NEW SPRING Clear MB MC



reddot design award
winner 2006

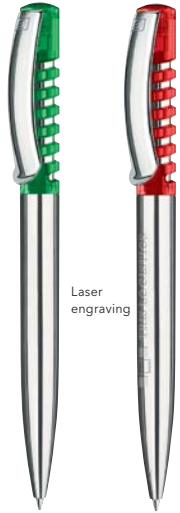

Laser
engraving

2561

2561

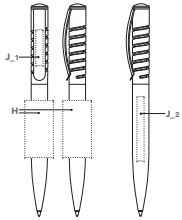

ART. NO. 2561

Push ball pen
Glossy transparent upper part, metal barrel,
metallised inner push-button, metal clip
senator® magic flow G2 refill (1.0 mm)
ink colour: blue or black

SERVICES

PMS Service: from 20,000 pieces, see page 11

COLOURS



BRANDING / AREA

H	Metal print	40 x 20 mm	J_1	Laser engraving	30 x 6 mm
			J_2	Laser engraving	45 x 5 mm

NEW SPRING Polished MB MC



reddot design award
winner 2006



Laser
engraving

Laser
engraving

2431

2431

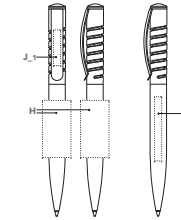

ART. NO. 2431

Push ball pen
Glossy opaque upper part, metal barrel,
metallised inner push-button, metal clip
senator® magic flow G2 refill (1.0 mm)
ink colour: blue or black

SERVICES

PMS Service: from 20,000 pieces, see page 11

COLOURS



BRANDING / AREA

H	Metal print	40 x 20 mm	J_1	Laser engraving	30 x 6 mm
			J_2	Laser engraving	45 x 5 mm

NEW SPRING Polished MC



reddot design award
winner 2006



HD
print

2310

2310

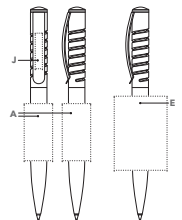

ART. NO. 2310

Push ball pen
Glossy opaque body surface, metallised
inner push-button, metal clip,
senator® magic flow G2 refill (1.0 mm)
ink colour: blue or black

SERVICES

PMS Service: from 20,000 pieces, see page 11

COLOURS



BRANDING / AREA

A	Screen print	40 x 20 mm	J	Laser engraving	30 x 6 mm
E	HD print 360° on white barrel	51 x 37 mm			

SOFT SPRING Polished

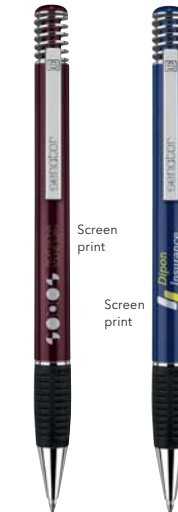

Screen
print

Screen
print

2067

2067

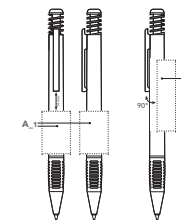

ART. NO. 2067

Push ball pen
Glossy opaque body surface with metallic
pigments (except for white and black),
metallised tip and spring, black soft grip
zone, metal clip,

senator® magic flow G2 refill (1.0 mm)
ink colour: blue or black

SERVICES

PMS Service: from 20,000 pieces, see page 11

COLOURS

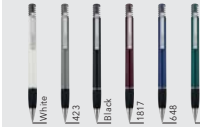

BRANDING / AREA

A_1	Screen print	30 x 20 mm
A_2	Screen print	50 x 13 mm

MATRIX Clear



2319 2319

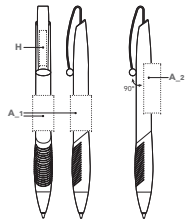

ART. NO. 2319

Push ball pen
Glossy transparent body surface, black soft grip zone, matt metal clip, senator® magic flow G2 refill (1.0 mm)
ink colour: blue or black

SERVICES

PMS Service: from 20,000 pieces, see page 11

COLOURS



BRANDING / AREA

A_1	Screen print	25 x 15 mm	H	Metal print	25 x 5 mm
A_2	Screen print	35 x 12 mm			

MATRIX Polished



2318 2318

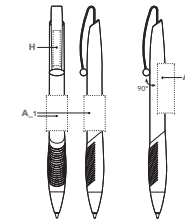

ART. NO. 2318

Push ball pen
Glossy opaque body surface, black soft grip zone, matt metal clip, senator® magic flow G2 refill (1.0 mm)
ink colour: blue or black

SERVICES

PMS Service: from 20,000 pieces, see page 11

COLOURS



BRANDING / AREA

A_1	Screen print	25 x 15 mm	H	Metal print	25 x 5 mm
A_2	Screen print	35 x 12 mm			

MATRIX Clear MT



2434 2434

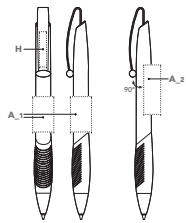

ART. NO. 2434

Push ball pen
Glossy transparent surface, black soft grip, matt metal tip and clip, senator® magic flow G2 refill (1.0 mm)
ink colour: blue or black

SERVICES

PMS Service: from 20,000 pieces, see page 11

COLOURS



BRANDING / AREA

A_1	Screen print	25 x 15 mm	H	Metal print	25 x 5 mm
A_2	Screen print	35 x 12 mm			

DUO PEN Polished



2122 2122

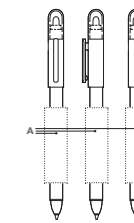

ART. NO. 2122

Twist mechanism ball pen
Glossy opaque body surface, combination of ball pen with black ink and yellow highlighter.

SERVICES

PMS Service: from 30,000 pieces, see page 11

COLOURS



BRANDING / AREA

A	Screen print	50 x 15 mm			1 colour
---	--------------	------------	--	--	----------



POLAR

**COOL LOOK
MADE IN GERMANY.**

This ball pen made in Germany combines a modern, linear design with exceptional quality at an unbeatably attractive price. A success all along the line.

**POLAR
Mix & Match**

NEW



3261 3261

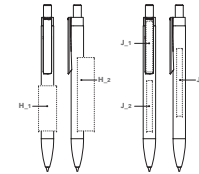

ART. NO. 3261

Push ball pen
Barrel: Metal, varnished
Fittings: Metal, glossy chrome
senator® magic flow G2 refill (1.0 mm)
Ink colour: blue or black

SERVICES

PMS Service (Barrel and Clip holder): from 10,000 pieces
Additional refill option:
senator® magic flow G2 refill (1.4 mm)

COLOURS



BRANDING / AREA

H_1 Metal print	40 x 16 mm	J_1 Laser engraving	45 x 6 mm
H_2 Metal print	65 x 15 mm	J_2 Laser engraving	45 x 5 mm
		J_3 Laser engraving	60 x 5 mm

**POLAR
Ball pen**



3260 3260

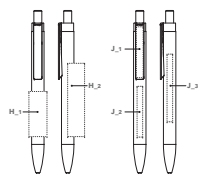

ART. NO. 3260

Push ball pen
Barrel: Metal, varnished
Fittings: Metal, glossy chrome
senator® magic flow G2 refill (1.0 mm)
Ink colour: blue

SERVICES

PMS Service (Barrel and Clip holder): from 10,000 pieces, see page 11

CORRESPONDING CASES

ET 169, ET 171, ET 160, ET 154, ET 157, see page 76 - 77

COLOURS



BRANDING / AREA

H_1 Metal print	40 x 16 mm
H_2 Metal print	65 x 15 mm
J_1 Laser engraving	45 x 6 mm
J_2 Laser engraving	45 x 5 mm
J_3 Laser engraving	60 x 5 mm

**DEVON
Ball pen**



2789 2789

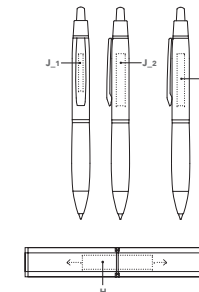

ART. NO. 2789

Push ball pen
Barrel: Metal, lacquered, with black soft grip section; Fittings: Metal, glossy chrome
Tip: Metal, lacquered, black
senator® metal refill, G2
Ink colour: blue

ART. NO. 6789

Set
Push ball pen 2789 in case ET 169

CORRESPONDING CASES

ET 150, ET 157, ET 160, ET 169, ET 181 see page 76 - 77

SERVICES

PMS Service: from 20,000 pieces see page 11

COLOURS



SET



BRANDING / AREA

Writing instrument:	
H Metal print	35 x 5 mm 1 colour
J_1 Laser engraving	25 x 3 mm
J_2 Laser engraving	35 x 6 mm

Case:	
H Case print	60 x 12 mm 1 colour

STAR TEC STEEL Ball pen + Pencil

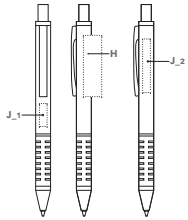

ART. NO. 2040

Push ball pen
Barrel: Metal, brushed
Fittings: Metal, glossy chrome
Soft grip zone: black
senator® metal refill, G2
Ink colour: blue

CORRESPONDING CASES

ET 150, ET 154, ET 156, ET 157, ET 160,
ET 169, ET 181
see page 76-77

COLOURS



BRANDING / AREA

H Metal print 40 x 12 mm

ART. NO. 3004

Mechanical pencil
Barrel: Metal, brushed
Fittings: Metal, glossy chrome
Soft grip zone: black
0.5 mm Hi-Polymer pencil lead

SERVICES

PMS Service: from 10,000 pieces
see page 11

J_1 Laser engraving 15 x 5 mm

J_2 Laser engraving 40 x 5 mm

STAR TEC ALU Ball pen + Pencil

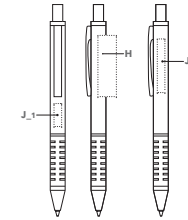

ART. NO. 2511

Push ball pen
Barrel: Metal, lacquered
Fittings: Metal, glossy chrome
Soft grip zone: black
senator® metal refill, G2
Ink colour: blue

CORRESPONDING CASES

ET 150, ET 154, ET 156, ET 157, ET 160,
ET 169, ET 171, ET 181
see page 76-77

COLOURS 2511



BRANDING / AREA

H Metal print 40 x 12 mm

ART. NO. 3111

Mechanical pencil
Barrel: Metal, lacquered
Fittings: Metal, glossy chrome
Soft grip zone: black
0.5 mm Hi-Polymer pencil lead

SERVICES

PMS Service: from 10,000 pieces
see page 11

COLOURS 3111



J_1 Laser engraving 15 x 5 mm

J_2 Laser engraving 40 x 5 mm

STAR TEC STEEL Set

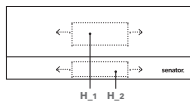

ART. NO. 6341

Set
Push ball pen 2040 + mechanical pencil 3004
in case ET 156, black

SERVICES

PMS Service: from 10,000 pieces
see page 11

COLOURS



BRANDING / AREA

Pens:
see art. 2040, 3004

Case:
H_1 Case print 50 x 20 mm

1 colour

H_2 Case print 50 x 15 mm

1 colour

STAR TEC ALU Set

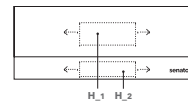

ART. NO. 6342

Set
Push ball pen 2511 + mechanical pencil 3111
in black case ET 156

SERVICES

PMS Service: from 10,000 pieces
see page 11

COLOURS



BRANDING / AREA

Pens:
see art. 2511, 3111

Case:
H_1 Case print 50 x 20 mm

1 colour

H_2 Case print 50 x 15 mm

1 colour

DELGADO CLASSIC

Ball pen + Rollerball

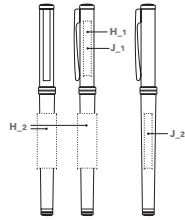

ART. NO. 2240

Push ball pen
Barrel: Metal, lacquered
Fittings: Metal, gilt
senator® metal refill, G2
Ink colour: blue

CORRESPONDING CASES

ET 150, ET 154, ET 156, ET 157, ET 160,
ET 169, ET 171, ET 181
see page 76-77

COLOURS



BRANDING / AREA

H_1 Metal print 35 x 5 mm
1 colour
H_2 Metal print 35 x 12 mm
1 colour

ART. NO. 1030

Rollerball
Barrel: Metal, lacquered
Fittings: Metal, gilt
Plastic safety rollerball refill
Ink colour: blue

SERVICES

PMS Service: from 10,000 pieces
see page 11

J_1 Laser engraving 35 x 5 mm
J_2 Laser engraving 35 x 5 mm

DELGADO CLASSIC STEEL

Ball pen + Rollerball

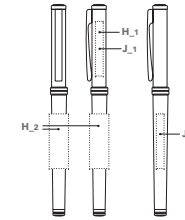

ART. NO. 2239

Push ball pen
Barrel: Metal, stainless steel finish
Fittings: Metal, gilt
senator® metal refill, G2
Ink colour: blue

CORRESPONDING CASES

ET 150, ET 154, ET 156, ET 157, ET 160,
ET 169, ET 171, ET 181
see page 76-77

COLOURS

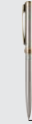

BRANDING / AREA

H_1 Metal print 35 x 5 mm
1 colour
H_2 Metal print 35 x 12 mm
1 colour

ART. NO. 1029

Rollerball
Barrel: Metal, stainless steel finish
Fittings: Metal, gilt
Plastic safety rollerball refill
Ink colour: blue

SERVICES

PMS Service: from 10,000 pieces
see page 11

J_1 Laser engraving 35 x 5 mm
J_2 Laser engraving 35 x 5 mm

DELGADO CLASSIC

Set

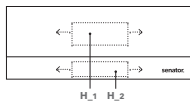

ART. NO. 6101

Set
Push ball pen 2240 + Rollerball 1030
in black case ET 156

SERVICES

PMS Service: from 10,000 pieces
see page 11

COLOURS



BRANDING / AREA

Pens:
see art. 1030, 2240

Case:
H_1 Case print 50 x 20 mm
1 colour
H_2 Case print 50 x 15 mm
1 colour

DELGADO CLASSIC STEEL

Set

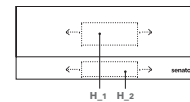

ART. NO. 6100

Set
Push ball pen 2239 + Rollerball 1029
in black case ET 156

SERVICES

PMS Service: from 10,000 pieces
see page 11

COLOURS

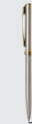

BRANDING / AREA

Pens:
see art. 1029, 2239

Case:
H_1 Case print 50 x 20 mm
1 colour
H_2 Case print 50 x 15 mm
1 colour

DELGADO METALLIC Ball pen + Rollerball



Metal
print

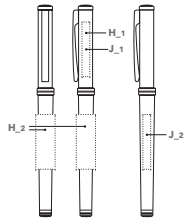

2241

1031

ART. NO. 2241

Push ball pen
Barrel: Metal, lacquered
Fittings: Metal, glossy chrome
senator® metal refill G2
Ink colour: blue

CORRESPONDING CASES

ET 150, ET 154, ET 156, ET 157, ET 160,
ET 169, ET 171, ET 181
see page 76-77

COLOURS



BRANDING / AREA

H_1 Metal print 35 x 5 mm
1 colour
H_2 Metal print 35 x 12 mm
1 colour

ART. NO. 1031

Rollerball
Barrel: Metal, lacquered
Fittings: Metal, glossy chrome
Plastic safety rollerball refill
Ink colour: blue

SERVICES

PMS Service: from 10,000 pieces
see page 11

J_1 Laser engraving 35 x 5 mm
J_2 Laser engraving 35 x 5 mm

DELGADO STEEL Ball pen + Rollerball



Laser
engraving

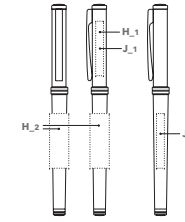

2242

1039

ART. NO. 2242

Push ball pen
Barrel: Metal, stainless steel finish
Fittings: Metal glossy chrome
senator® metal refill, G2
Ink colour: blue

CORRESPONDING CASES

ET 150, ET 154, ET 156, ET 157, ET 160,
ET 169, ET 171, ET 181
see page 76-77

COLOURS



BRANDING / AREA

H_1 Metal print 35 x 5 mm
1 colour
H_2 Metal print 35 x 12 mm
1 colour

ART. NO. 1039

Rollerball
Barrel: Metal, stainless steel finish
Fittings: Metal, glossy chrome
Plastic safety rollerball refill
Ink colour: blue

SERVICES

PMS Service: from 10,000 pieces
see page 11

J_1 Laser engraving 35 x 5 mm
J_2 Laser engraving 35 x 5 mm

DELGADO METALLIC Set



6102

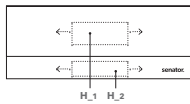

ART. NO. 6102

Set
Push ball pen 2241 + Rollerball 1031
in black case ET 156

SERVICES

PMS Service: from 10,000 pieces
see page 11

COLOURS



BRANDING / AREA

Pens:
see art. 1031, 2241

Case:
H_1 Case print 50 x 20 mm
1 colour
H_2 Case print 50 x 15 mm
1 colour

DELGADO STEEL Set



6114

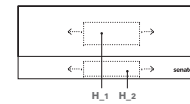

ART. NO. 6114

Set
Push ball pen 2242 + Rollerball 1039
in black case ET 156

SERVICES

PMS Service: from 10,000 pieces
see page 11

COLOURS



BRANDING / AREA

Pens:
see art. 1039, 2242

Case:
H_1 Case print 50 x 20 mm
1 colour
H_2 Case print 50 x 15 mm
1 colour

NAUTIC

Ball pen

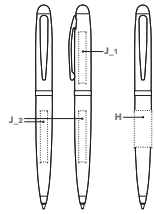

2215 2215

ART. NO. 2215

Twist ball pen
Barrel and fittings: Metal, glossy chrome
Cap: Metal, soft lacquer
senator® metal refill, G2
Ink colour: blue

CORRESPONDING CASES

ET 150, ET 154, ET 156, ET 157, ET 160,
ET 169, ET 171, ET 181
see page 76-77

SERVICES

PMS Service: from 5,000 pieces
see page 11

COLOURS



BRANDING / AREA

H	Metal print	25 x 12 mm 1 colour	J_1	Laser engraving	35 x 5 mm
			J_2	Laser engraving	35 x 5 mm

NAUTIC

Ball pen/Touch Pad Pen

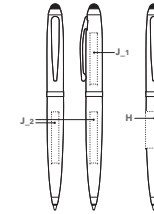

2754 2754

ART. NO. 2754

Twist ball pen with touch pad function
Barrel and fittings: Metal, glossy chrome
Cap: Metal, soft lacquer
senator® metal refill, G2
Ink colour: blue

CORRESPONDING CASES

ET 150, ET 154, ET 156, ET 157, ET 160,
ET 169, ET 171, ET 181
see page 76-77

SERVICES

PMS Service: from 5,000 pieces
see page 11

COLOURS



BRANDING / AREA

H	Metal print	25 x 12 mm 1 colour	J_1	Laser engraving	35 x 5 mm
			J_2	Laser engraving	35 x 5 mm

NAUTIC

Rollerball

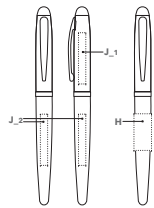

1092 1092

ART. NO. 1092

Rollerball
Barrel and fittings: Metal, glossy chrome
Cap and grip zone: Metal, soft lacquer
Metal safety rollerball refill
Ink colour: blue

CORRESPONDING CASES

ET 150, ET 154, ET 156, ET 157, ET 160,
ET 169, ET 171, ET 181
see page 76-77

SERVICES

PMS Service: from 5,000 pieces
see page 11

COLOURS



BRANDING / AREA

H	Metal print	25 x 12 mm 1 colour	J_1	Laser engraving	35 x 5 mm
			J_2	Laser engraving	35 x 5 mm

NAUTIC

Set



6297

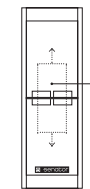

ART. NO. 6297

Set
Touch Pad Pen 2754 + Rollerball 1092
in case ET 171

SERVICES

PMS Service: from 5,000 pieces
see page 11

COLOURS



BRANDING / AREA

Pens: see art. 1092, 2215, 2754	Case: H Case print	60 x 25 mm 1 colour
------------------------------------	------------------------------	------------------------

VISIR

Ball pen + Rollerball



Metal print

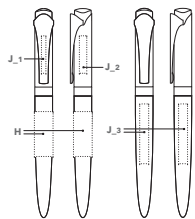

ART. NO. 2253

Twist ball pen
Barrel: Metal, glossy lacquered
Fittings: Metal, glossy chrome
senator® metal refill, G2
Ink colour: blue

CORRESPONDING CASES

ET 150, ET 154, ET 156, ET 157, ET 160,
ET 169, ET 171, ET 181
see page 76-77

COLOURS



BRANDING / AREA

H Metal print 30 x 12 mm
1 colour

ART. NO. 1056

Rollerball
Barrel: Metal, glossy lacquered
Fittings and cap: Metal, glossy chrome
Metal safety rollerball refill
Ink colour: blue

SERVICES

PMS Service: from 10,000 pieces
see page 11

J_1 Laser engraving 25 x 3 mm

J_2 Laser engraving 25 x 5 mm

J_3 Laser engraving 40 x 6 mm

VISIR

Set



6298

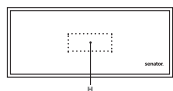

ART. NO. 6298

Set
Twist ball pen 2253 + Rollerball 1056
in case ET 160

SERVICES

PMS Service: from 10,000 pieces
see page 11

COLOURS



BRANDING / AREA

Pens:
see art. 1056, 2253

Case:
H Case print 50 x 20 mm
1 colour

SIGNER LINER®

Ball pen

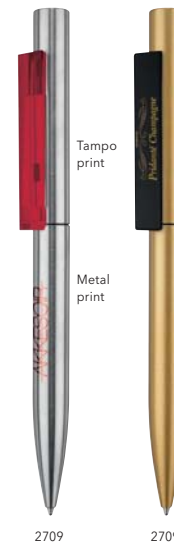

2709

2709

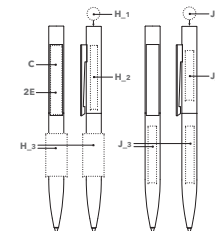

ART. NO. 2709

Twist ball pen
Barrel: Stainless steel, sandblasted or
lacquered

Clip: Plastic: clear or polished
senator® magic flow G2 refill (1.0 mm)
Ink colour: blue

CORRESPONDING CASES

ET 150, ET 154, ET 156, ET 160,
ET 169, ET 171, ET 181
see page 76-77

SERVICES

PMS Service (clip): from 10,000 pieces
see page 11

COLOURS

Barrel	Steel	Barrel	Copper	Gun metal	Gold
Metal, sandblasted		Metal, lacquered			
Clip clear		Clip polished			
Clear 186	286	White	Black 485	Magenta 288	

BRANDING / AREA

C Tampo print 47 x 7 mm

H_1 Steel: Ø 9 mm
Metal print 1 colour

H_2 Metal print 45 x 5 mm
1 colour

H_3 Metal print 30 x 15 mm
1 colour

J_1 Laser engraving Ø 9 mm

J_2 Laser engraving 35 x 6 mm

J_3 Laser engraving 40 x 6 mm

2E Digital clip print 48.5 x 8 mm

IMAGE® CHROME

Ball pen



2158

2158

ART. NO. 2158

Twist ball pen
Barrel: Metal, soft varnish
Fittings: Metal, matt chrome
senator® metal refill, G2
Ink colour: blue

CORRESPONDING CASES

ET 150, ET 154, ET 156, ET 157, ET 160,
ET 169, ET 171, ET 181
see page 76-77

SERVICES

PMS Service: from 5,000 pieces
see page 11

COLOURS



BRANDING / AREA

J_1 Laser engraving 35 x 5 mm

J_2 Laser engraving 35 x 5 mm

IMAGE® CHROME

Rollerball

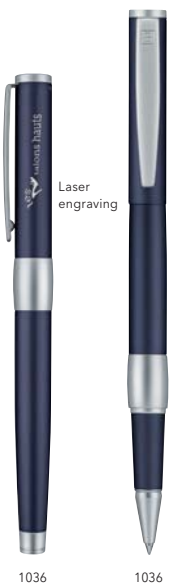

1036

1036

ART. NO. 1036

Rollerball
Barrel: Metal, soft varnish
Fittings: Metal, matt chrome
Metal safety rollerball refill
Ink colour: blue

CORRESPONDING CASES

ET 150, ET 154, ET 156, ET 157, ET 160,
ET 169, ET 171, ET 181
see page 76-77

SERVICES

PMS Service: from 5,000 pieces
see page 11

COLOURS



BRANDING / AREA

J_1 Laser engraving 35 x 5 mm

J_2 Laser engraving 35 x 5 mm

IMAGE® CHROME

Fountain pen

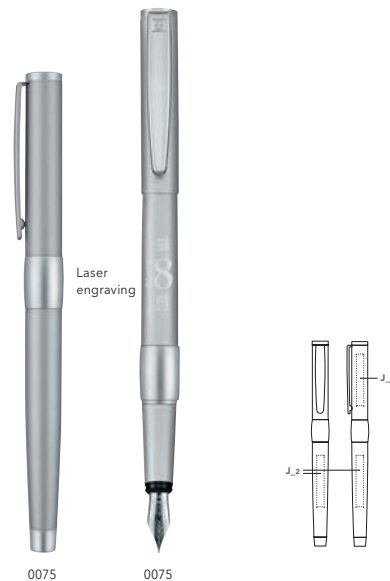

0075

0075

ART. NO. 0075

Fountain pen
Barrel: Metal, soft varnish
Fittings: Metal, matt chrome
Iridium-tipped stainless steel nib
Standard ink cartridge
Ink colour: blue

CORRESPONDING CASES

ET 150, ET 154, ET 156, ET 157, ET 160,
ET 169, ET 171, ET 181
see page 76-77

SERVICES

PMS Service: from 5,000 pieces
see page 11

COLOURS



BRANDING / AREA

J_1 Laser engraving 35 x 5 mm

J_2 Laser engraving 35 x 5 mm

IMAGE® CHROME

Sets

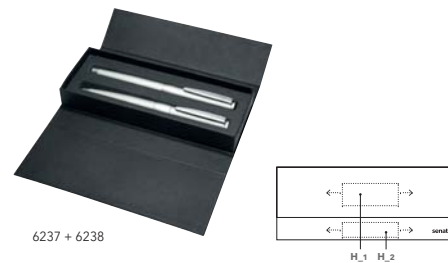

6237 + 6238



6089 + 6117

ART. NO. 6237

Set
Twist ball pen 2158 + Fountain pen 0075
in black case ET 156

BRANDING / AREA

Pens:
see art. 0075, 1036, 2158

ART. NO. 6238

Set
Twist ball pen 2158 + Rollerball 1036
in black case ET 156

Case:
H_1 Case print 50 x 20 mm, 1 c
H_2 Case print 50 x 15 mm, 1 c

ART. NO. 6089

Set
Twist ball pen 2158 + Rollerball 1036
in presentation box SC 197 with leather
wallet ET 150

BRANDING / AREA

Pens:
see art. 0075, 1036, 2158

ART. NO. 6117

Set
Twist ball pen 2158 + Fountain pen 0075
in presentation box SC 197 with leather
wallet ET 150

Case:
EB Embossing 22 x 30 mm

IMAGE® BLACK LINE

Ball pen



2636 2636

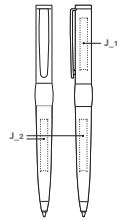

ART. NO. 2636

Twist ball pen
Barrel: Metal, soft varnish
Fittings: Metal, gun metal
senator® metal refill, G2
Ink colour: blue

CORRESPONDING CASES

ET 150, ET 154, ET 156, ET 157, ET 160,
ET 169, ET 171, ET 181
see page 76-77

SERVICES

PMS Service: from 5,000 pieces
see page 11

COLOURS



BRANDING / AREA

J_1 Laser engraving 35 x 5 mm
J_2 Laser engraving 35 x 5 mm

IMAGE® BLACK LINE

Fountain pen



0104 0104

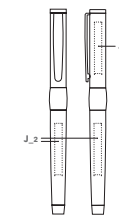

ART. NO. 0104

Fountain pen
Barrel: Metal, soft varnish
Fittings: Metal gun metal
Iridium-tipped stainless steel nib, M
Standard ink cartridge
Ink colour: blue

CORRESPONDING CASES

ET 150, ET 154, ET 156, ET 157, ET 160,
ET 169, ET 171, ET 181
see page 76-77

SERVICES

PMS Service: from 5,000 pieces
see page 11

COLOURS



BRANDING / AREA

J_1 Laser engraving 35 x 5 mm
J_2 Laser engraving 35 x 5 mm

IMAGE® BLACK LINE

Rollerball



1119 1119

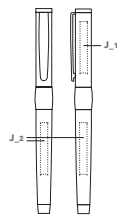

ART. NO. 1119

Rollerball
Barrel: Metal, soft varnish
Fittings: Metal, gun metal
Metal safety rollerball refill
Ink colour: blue

CORRESPONDING CASES

ET 150, ET 154, ET 156, ET 157, ET 160,
ET 169, ET 171, ET 181
see page 76-77

SERVICES

PMS Service: from 5,000 pieces
see page 11

COLOURS



BRANDING / AREA

J_1 Laser engraving 35 x 5 mm
J_2 Laser engraving 35 x 5 mm

IMAGE® BLACK LINE

Sets



6205 + 6206

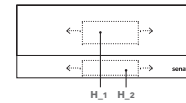

ART. NO. 6205

Set
Twist ball pen 2636 + Fountain pen 0104
in black case ET 156

BRANDING / AREA

Pens:
see art. 0104, 1119, 2636

ART. NO. 6206

Set
Twist ball pen 2636 + Rollerball 1119
in black case ET 156

Case:
H_1 Case print 50 x 20 mm, 1 c
H_2 Case print 50 x 15 mm, 1 c

IMAGE® WHITE LINE

Ball pen

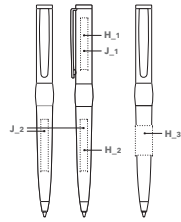

ART. NO. 2786

Twist ball pen
Barrel: metal, glossy lacquered
Fittings: Glossy chrome
senator® metal refill, G2
Ink colour: blue

CORRESPONDING CASES

ET 150, ET 154, ET 156, ET 157, ET 160,
ET 169, ET 171, ET 181
see page 76-77

COLOURS



BRANDING / AREA

H_1 Metal print 35 x 5 mm
1 colour
H_2 Metal print 35 x 5 mm
1 colour
H_3 Metal print 20 x 12 mm
1 colour

SERVICES

PMS Service: from 5,000 pieces
see page 11

J_1 Laser engraving 35 x 5 mm
J_2 Laser engraving 35 x 5 mm

IMAGE® WHITE LINE

Fountain pen

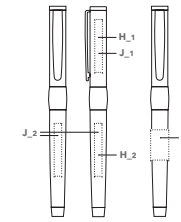

ART. NO. 0106

Fountain pen
Barrel: Metal, glossy lacquered
Fittings: Glossy chrome
Iridium-tipped stainless steel nib, M
Standard ink cartridge
Ink colour: Royal blue

CORRESPONDING CASES

ET 150, ET 154, ET 156, ET 157, ET 160,
ET 169, ET 171, ET 181
see page 76-77

COLOURS



BRANDING / AREA

H_1 Metal print 35 x 5 mm
1 colour
H_2 Metal print 35 x 5 mm
1 colour
H_3 Metal print 20 x 12 mm
1 colour

SERVICES

PMS Service: from 5,000 pieces
see page 11

J_1 Laser engraving 35 x 5 mm
J_2 Laser engraving 35 x 5 mm

IMAGE® WHITE LINE

Rollerball

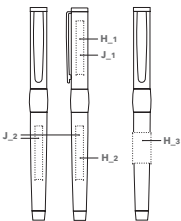

ART. NO. 1146

Rollerball
Barrel: metal, glossy lacquered
Fittings: Glossy chrome
Metal safety rollerball refill
Ink colour: blue

CORRESPONDING CASES

ET 150, ET 154, ET 156, ET 157, ET 160,
ET 169, ET 171, ET 181
see page 76-77

COLOURS



BRANDING / AREA

H_1 Metal print 35 x 5 mm
1 colour
H_2 Metal print 35 x 5 mm
1 colour
H_3 Metal print 20 x 12 mm
1 colour

SERVICES

PMS Service: from 5,000 pieces
see page 11

J_1 Laser engraving 35 x 5 mm
J_2 Laser engraving 35 x 5 mm

IMAGE® WHITE LINE

Sets



6266 + 6267

ART. NO. 6266

Set
Twist ball pen 2786 + Fountain pen 0106
in white case ET 156

SERVICES

PMS Service: from 5,000 pieces
see page 11

COLOURS



BRANDING / AREA

Pens:
see art. 0106, 1146, ET 156, 2786

ART. NO. 6267

Set
Twist ball pen 2786 + Rollerball 1146
in white case ET 156

CARBON LINE

Ball pen



2159

2159

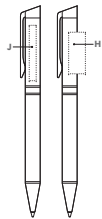

ART. NO. 2159

Twist ball pen
Metal in combination with light carbon
Cap, tip, fittings: Metal, matt chrome
senator® metal refill, G2
Ink colour: blue

CORRESPONDING CASES

ET 150, ET 154, ET 157, ET 160,
ET 169, ET 171, ET 181
see page 76-77

COLOURS



BRANDING / AREA

H	Metal print	30 x 12 mm	J	Laser engraving	40 x 5 mm
		1 colour			

CARBON LINE

Fountain pen



0076

0076

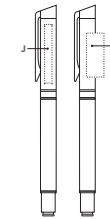

ART. NO. 0076

Fountain pen
Metal in combination with light carbon
Cap, tip, fittings: Metal, matt chrome
Iridium-tipped stainless steel nib, M
Standard ink cartridge
Ink colour: blue

CORRESPONDING CASES

ET 150, ET 154, ET 156, ET 157, ET 160,
ET 169, ET 171, ET 181
see page 76-77

COLOURS



BRANDING / AREA

H	Metal print	30 x 12 mm	J	Laser engraving	40 x 5 mm
		1 colour			

CARBON LINE

Rollerball



1037

1037

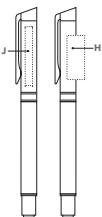

ART. NO. 1037

Rollerball
Metal in combination with light carbon
Cap, tip, fittings: Metal, matt chrome
Metal safety rollerball refill
Ink colour: blue

CORRESPONDING CASES

ET 150, ET 154, ET 156, ET 157, ET 160,
ET 169, ET 171, ET 181
see page 76-77

COLOURS



BRANDING / AREA

H	Metal print	30 x 12 mm	J	Laser engraving	40 x 5 mm
		1 colour			

CARBON LINE

Sets



6239 + 6240

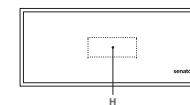

ART. NO. 6239

Set
Twist ball pen 2159 + Fountain pen 0076
in black case ET 160

ART. NO. 6240

Set
Twist ball pen 2159 + Rollerball 1037
in black case ET 160

COLOURS



BRANDING / AREA

Pens: see art. 0076, 1037, 2159	Case: H Case print	50 x 20 mm
		1 colour

TIZIO

Ball pen



2400 2400



ART. NO. 2400

Twist ball pen
Barrel: Metal in combination with nutwood
Cap, tip, fittings: Metal, glossy chrome
senator® metal refill, G2
Ink colour: blue

CORRESPONDING CASES

ET 150, ET 154, ET 157, ET 160,
ET 169, ET 171, ET 181,
see page 76-77

COLOURS



BRANDING / AREA

J Laser engraving 40 x 5 mm

TIZIO

Rollerball



1240 1240



ART. NO. 1240

Rollerball
Barrel: Metal in combination with nutwood
Cap, tip, fittings: Metal, glossy chrome
Metal safety rollerball refill
Ink colour: blue

CORRESPONDING CASES

ET 150, ET 154, ET 156, ET 157, ET 160,
ET 169, ET 181
see page 76-77

COLOURS



BRANDING / AREA

J Laser engraving 40 x 5 mm

TIZIO

Fountain pen



0240 0240



ART. NO. 0240

Fountain pen
Barrel: Metal in combination with nutwood
Cap, fittings: Metal, glossy chrome
Iridium-tipped stainless steel nib, M

Standard ink cartridge
Ink colour: blue

CORRESPONDING CASES

ET 150, ET 154, ET 156, ET 157, ET 160,
ET 169, ET 181
see page 76-77

COLOURS



BRANDING / AREA

J Laser engraving 40 x 5 mm

TIZIO

Sets



6252 + 6253

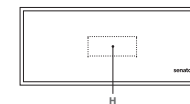

ART. NO. 6252

Set
Twist ball pen 1240 + Fountain pen 0240
in black case ET 156

ART. NO. 6253

Set
Twist ball pen 2400 + Rollerball 1240
in black case ET 156

COLOURS



BRANDING / AREA

Writing instruments:
see separate article

Case:
H Case print 50 x 20 mm
1 colour

SOLARIS

Ball pen + Rollerball

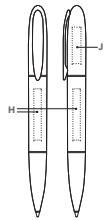

ART. NO. 2479

Twist ball pen
Barrel: Metal, textured polished with transparent plastic casing
Fittings: Metal, glossy chrome
senator® metal refill, G2
Ink colour: blue

CORRESPONDING CASES

ET 150, ET 157, ET 160, ET 169,
ET 171, ET 181
see page 76-77

COLOURS



BRANDING / AREA

H Metal print 35 x 5 mm
(not on clear) 1 colour

ART. NO. 1479

Rollerball
Barrel: Metal, textured polished with transparent plastic casing
Fittings: Metal, glossy chrome
Metal safety rollerball refill
Ink colour: blue

SERVICES

PMS Service: from 5,000 pieces
see page 11

J Laser engraving 25 x 6 mm

SOLARIS

Set



6480

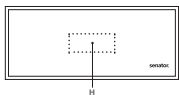

ART. NO. 6480

Set
Twist ball pen 2479 + Rollerball 1479
in case ET 160

SERVICES

PMS Service: from 5,000 pieces
see page 11

COLOURS



BRANDING / AREA

Pens:
See art. 1479, 2479

Case:
H Case print 50 x 20 mm
1 colour

CASES

This list indicates which gift case fits which pen model. The crosses marked in grey are our recommendations.

	ET 150	ET 154	ET 156	ET 157	ET 160	ET 169	ET 171	ET 181
Big Pen	x				x			x
Bridge	x	x	x	x	x	x	x	x
Carbon Line twist ball pen	x	x		x	x	x	x	x
Carbon Line rollerball/fountain pen	x	x	x	x	x	x	x	x
Centrix	x	x			x			x
Challenger	x	x		x	x	x	x	x
Challenger with soft grip	x	x		x	x	x		x
Dart	x	x	x	x	x	x	x	x
Delgado	x	x	x	x	x	x	x	x
Devon	x			x	x	x		x
Duo Pen	x	x	x	x	x	x	x	x
Hatrix	x	x		x	x	x	x	x
Hatrix with soft grip	x			x	x	x		x
Image	x	x	x	x	x	x	x	x
Liberty®	x	x		x	x	x	x	x
Matrix	x			x	x	x		x
Nature Plus	x	x		x	x	x	x	x
Nautic	x	x	x	x	x	x	x	x
New Spring	x	x		x	x	x	x	x
Point	x	x	x	x	x	x	x	x
Polar		x		x	x	x	x	
Signer Liner®	x	x	x		x	x	x	x
Soft Spring	x	x		x	x	x		x
Star Tec	x	x	x	x	x	x	x	x
Solaris	x			x	x	x	x	x
Super Hit	x	x		x	x	x	x	x
Super Hit with soft grip	x	x		x	x	x		x
Tizio twist ball pen	x	x		x	x	x	x	x
Tizio rollerball / fountain pen	x		x	x	x	x		x
Visir	x	x	x	x	x	x	x	x

CASES



ET 181

ART. NO. ET 181

Handy cardboard packaging for the attractive presentation of a ball pen; suitable for all senator® ball pens, white cardboard with a customised 4 colour print

Dimensions: 16.6 x 15.2 cm (open)

BRANDING / AREA

4c print 166 x 152 mm
both sides

ART. NO. ET 157

For 1 writing instrument; carton, matt black, at 5,000 pcs. also available in different colours

Dimensions: 15.5 x 5 x 0.2 cm



ET 157

ART. NO. ET 169

For 1 writing instrument; plastic, glossy transparent with universal pen holder

Dimensions: 15.5 x 2.5 x 2.5 cm

BRANDING / AREA

H Case print 60 x 12 mm
1 colour



ET 169

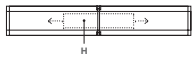

ART. NO. ET 171

For 2 writing instruments; Plastic, glossy transparent with universal pen holder

Dimensions: 15.5 x 5.5 x 2.5 cm

BRANDING / AREA

H Case print 60 x 25 mm
1 colour



ET 171

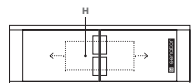

CASES



ET 154

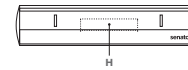

ET 156

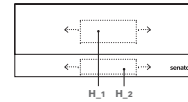

ET 160

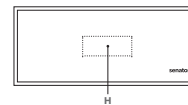

ET 150

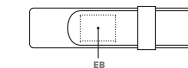

ART. NO. ET 154

Suitable for 1 writing instrument; plastic, black/silver with transparent lid, also available for slim writing instruments

Dimensions: 16 x 3.5 x 2.5 cm

BRANDING / AREA

H Case print 50 x 10 mm
1 colour

ART. NO. ET 156

For 1 or 2 writing instruments; carded case, black matt or glossy white with magnetic closure and foam inlay

Dimensions: 16.5 x 6.5 x 2.5 cm

BRANDING / AREA

H_1 Case print 50 x 20 mm
not on white 1 colour
H_2 Case print 50 x 15 mm
not on white 1 colour

ART. NO. ET 160

For 1 or 2 writing instruments; leather look, black with black velour lining

Dimensions: 19 x 8 x 3.5 cm

BRANDING / AREA

H Case print 50 x 20 mm
1 colour

ART. NO. ET 150

For 1 or 2 writing instruments; leather, black

Dimensions: 15 x 3.5 x 1.5 cm

BRANDING / AREA

EB Embossing 30 x 22 mm



TO GO

**LOOKS
COOL.
KEEPS
HOT.**

senator® mugs "To Go" are the perfect every day companions. These vacuum thermo mugs keep hot drinks hot and cold drinks cold. Useful, long lasting and so popular.

KING CAN



0755

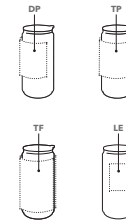

TROPHY



0750

Transfer print
partial cover

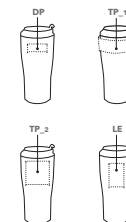

ART. NO. 0755

Vacuum thermo mug, double-walled 18/8 stainless steel, including sublimation print, with black plastic lid

DIMENSIONS

Height: ~ 150 mm
Diameter: ~ 71 mm
Capacity: ~ 0.33 l

SERVICES

As standard packed in white cardboard box

COLOURS



BRANDING / AREA

DP Direct print	170 x 80 mm, up to 3 colours	TF Transfer print full cover	210 x 115 mm
LE Engraving	12 cm ² (20 x 60 mm)	TP Transfer print partial cover	200 x 80 mm

ART. NO. 0750

Vacuum thermo mug, double-walled 18/8 stainless steel, with black plastic lid

DIMENSIONS

Height: ~ 170 mm
Diameter: ~ 82 mm
Capacity: ~ 0.4 l

SERVICES

As standard packed in white cardboard box

COLOURS



BRANDING / AREA

DP Direct print	50 x 20 mm up to 3 colours	TP_1 Transfer print full cover	150 x 30 mm
LE Engraving	12 cm ² (20 x 60 mm)	TP_2 Transfer print partial cover	60 x 60 mm



SUBLIMATION

**COLOURFUL
AND
SIMPLY
BRILLIANT.**

Do you really want to shine with your brand? Then the senator® Pics products are the perfect choice for you. Only senator® offers this unique combination of large-scale sublimation prints and stylish mug designs.



PICS KING CAN

NEW



Sublimation

0765

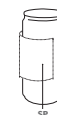

ART. NO. 0765

Vacuum thermo mug, double-walled 18/8 stainless steel, with black plastic lid, including sublimation

DIMENSIONS

Height: ~ 150 mm
Diameter: ~ 71 mm
Capacity: ~ 0.33 l

SERVICES

As standard packed in white cardboard box

COLOURS



BRANDING / AREA

SP Sublimation 150 x 80 mm

PICS AMITY



Sublimation

0359

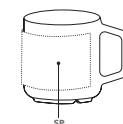

ART. NO. 0359

Stoneware mug, glossy white, including sublimation print

DIMENSIONS

Height: ~ 86 mm
Diameter: ~ 80 mm
Capacity: ~ 0.25 l

SERVICES

Packaging, see page 106 - 107

COLOURS



BRANDING / AREA

SP Sublimation 180 x 60 mm

PICS ONE



Sublimation

0323

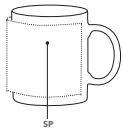

ART. NO. 0323

Stoneware mug, glossy white, including sublimation print

DIMENSIONS

Height: ~ 96 mm
Diameter: ~ 82 mm
Capacity: ~ 0.3 l

COLOURS



BRANDING / AREA

SP Sublimation 205 x 80 mm

SERVICES

Packaging, see page 106-107

PICS ELITE



Sublimation

0354



ART. NO. 0354

Stoneware mug, glossy white, including sublimation print

DIMENSIONS

Height: ~ 100 mm
Diameter: ~ 82 mm
Capacity: ~ 0.25 l

COLOURS



BRANDING / AREA

SP Sublimation 180 x 35 mm

SERVICES

Packaging, see page 106-107

PICS TWO



Sublimation

0324

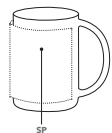

ART. NO. 0324

Stoneware mug, glossy white, including sublimation print

DIMENSIONS

Height: ~ 105 mm
Diameter: ~ 76 mm
Capacity: ~ 0.3 l

COLOURS



BRANDING / AREA

SP Sublimation 200 x 85 mm

SERVICES

Packaging, see page 106-107

PICS ELITE INSIDE



Sublimation

0355

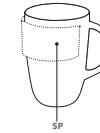

ART. NO. 0355

Stoneware mug, glossy white, including sublimation print, with a choice of 4 colours for inside

DIMENSIONS

Height: ~ 100 mm
Diameter: ~ 82 mm
Capacity: ~ 0.25 l

COLOURS



BRANDING / AREA

SP Sublimation 180 x 35 mm

SERVICES

Packaging, see page 106-107

PICS CLASSIC



Sublimation

0362

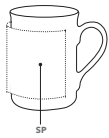

ART. NO. 0362

Stoneware mug, glossy white, including sublimation print

DIMENSIONS

Height: ~ 106 mm
Diameter: ~ 79 mm
Capacity: ~ 0.3 l

SERVICES

Packaging, see page 106-107

COLOURS



BRANDING / AREA

SP Sublimation 170 x 70 mm

PICS SWEEP



Sublimation

0357

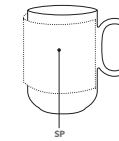

ART. NO. 0357

Stoneware mug, glossy white, including sublimation print

DIMENSIONS

Height: ~ 110 mm
Diameter: ~ 74 mm
Capacity: ~ 0.3 l

SERVICES

Packaging, see page 106-107

COLOURS



BRANDING / AREA

SP Sublimation 170 x 70 mm

PICS SOLID



Sublimation

0358

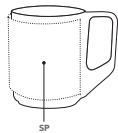

ART. NO. 0358

Stoneware mug, glossy white, including sublimation print

DIMENSIONS

Height: ~ 101 mm
Diameter: ~ 80 mm
Capacity: ~ 0.25 l

SERVICES

Packaging, see page 106-107

COLOURS



BRANDING / AREA

SP Sublimation 180 x 80 mm

PICS COSMOS



Sublimation

0356

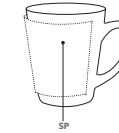

ART. NO. 0356

Stoneware mug, glossy white, including sublimation print

DIMENSIONS

Height: ~ 108 mm
Diameter: ~ 95 mm
Capacity: ~ 0.33 l

SERVICES

Packaging, see page 106-107

COLOURS



BRANDING / AREA

SP Sublimation 190 x 80 mm



DIRECT PRINT

**SAVES
TIME.
MAKES
MONEY.**

senator® Direct Print makes printing mugs so much easier and more attractive. With the Direct Print method we apply the ink directly onto the mug without any detour. This saves time and money.



FROZEN MUG



0970

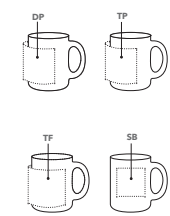

ART. NO. 0970
Glass mug, frosted white

DIMENSIONS
Height: ~ 97 mm
Diameter: ~ 80 mm
Capacity: ~ 0.25 l

SERVICES
Glossy Impression, see page 113
Packaging, see page 106 - 107

COLOURS

BRANDING / AREA

DP Direct print	180 x 65 mm, up to 3 colours	TP Transfer print partial cover	190 x 65 mm
SB Sand blasting	60 x 60 mm	TF Transfer print full cover	220 x 70 mm

FROZEN COLOUR



0972

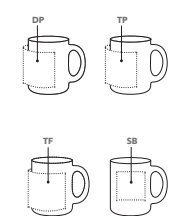

ART. NO. 0972
Glass mug, frosted

DIMENSIONS
Height: ~ 97 mm
Diameter: ~ 80 mm
Capacity: ~ 0.25 l

SERVICES
Glossy Impression, see page 113
Packaging, see page 106 - 107

COLOURS

BRANDING / AREA

DP Direct print	180 x 65 mm, up to 3 colours	TP Transfer print partial cover	190 x 65 mm
SB Sand blasting	60 x 60 mm	TF Transfer print full cover	220 x 70 mm



PRIME



0341

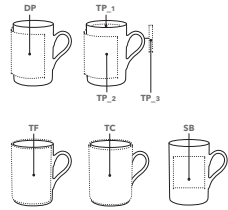

ART. NO. 0341

Porcelain mug, glossy white

DIMENSIONS

Height: ~ 106 mm
Diameter: ~ 74 mm
Capacity: ~ 0.25 l

SERVICES

Colour 4U, see page 111
Packaging, see page 106-107

COLOURS



BRANDING / AREA

DP	Direct print	150 x 70 mm, up to 4 colours	TP.1	Transfer print partial cover	50 x 20 mm
SB	Sand blasting	60 x 60 mm	TP.2	Transfer print partial cover	170 x 80 mm
TC	Transfer print full cover closed	226 x 100 mm	TP.3	Transfer print partial cover	50 x 5 mm
TF	Transfer print full cover	208 x 100 mm			

CLASSIC



0973

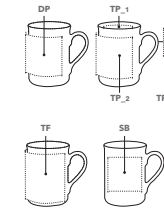

ART. NO. 0973

Porcelain mug, glossy white

DIMENSIONS

Height: ~ 104 mm
Diameter: ~ 78 mm
Capacity: ~ 0.25 l

SERVICES

Colour 4U, see page 111
Packaging, see page 106-107

COLOURS



BRANDING / AREA

DP	Direct print	165 x 70 mm, up to 4 colours	TP.1	Transfer print partial cover	50 x 20 mm
SB	Sand blasting	60 x 60 mm	TP.2	Transfer print partial cover	170 x 70 mm
TF	Transfer print full cover	210 x 90 mm	TP.3	Transfer print partial cover	50 x 5 mm

PRIME COLOUR



0351

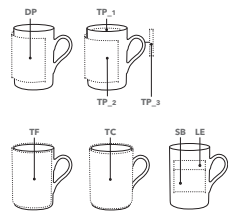

ART. NO. 0351

Stoneware mug, glossy coloured

DIMENSIONS

Height: ~ 103 mm
Diameter: ~ 74 mm
Capacity: ~ 0.25 l

SERVICES

Packaging, see page 106-107

COLOURS



BRANDING / AREA

DP	Direct print	150 x 70 mm, up to 3 colours	TF	Transfer print full cover	208 x 100 mm
LE	Engraving	12 cm ² (60 x 20 mm or 40 x 30 mm)	TP.1	Transfer print partial cover	50 x 20 mm
SB	Sand blasting	60 x 60 mm	TP.2	Transfer print partial cover	170 x 80 mm
TC	Transfer print full cover closed	226 x 100 mm	TP.3	Transfer print partial cover	50 x 5 mm

CULT



0911

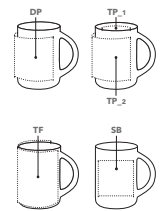

ART. NO. 0911

Porcelain mug, glossy white

DIMENSIONS

Height: ~ 104 mm
Diameter: ~ 75 mm
Capacity: ~ 0.25 l

SERVICES

Colour 4U, see page 111
Packaging, see page 106-107

COLOURS



BRANDING / AREA

DP	Direct print	165 x 70 mm, up to 4 colours	TP.1	Transfer print partial cover	50 x 20 mm
SB	Sand blasting	60 x 60 mm	TP.2	Transfer print partial cover	170 x 80 mm
TF	Transfer print full cover	208 x 100 mm			

AMITY



Direct print

Colour 4U + Sand blasting

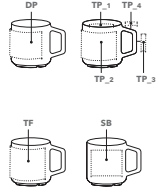

0321

ART. NO. 0321

Porcelain mug, glossy white, with water-release indents, suitable for coffee pad machines

DIMENSIONS

Height: ~ 85 mm
Diameter: ~ 80 mm
Capacity: ~ 0.25 l

SERVICES

Colour 4U, see page 111
Packaging, see page 106-107

COLOURS



BRANDING / AREA

DP	Direct print	170 x 55 mm, up to 4 colours	TP.1	Transfer print partial cover	50 x 20 mm
SB	Sand blasting	60 x 50 mm	TP.2	Transfer print partial cover	180 x 60 mm
TF	Transfer print full cover	220 x 70 mm	TP.3	Transfer print partial cover	40 x 8 mm
			TP.4	Transfer print partial cover	20 x 8 mm

ELITE INSIDE



Transfer print partial cover

0353

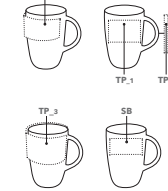

ART. NO. 0353

Stoneware mug, glossy white, with a choice of 4 colours for inside

DIMENSIONS

Height: ~ 100 mm
Diameter: ~ 82 mm
Capacity: ~ 0.25 l

SERVICES

Packaging, see page 106-107

COLOURS



BRANDING / AREA

DP	Direct print	175 x 35 mm, up to 4 colours	TP.1	Transfer print partial cover	60 x 50 mm
SB	Sand blasting	60 x 30 mm	TP.2	Transfer print partial cover	70 x 7 mm
			TP.3	Transfer print partial cover	215 x 50 mm

ELITE



Direct print

Colour 4U + Sand blasting

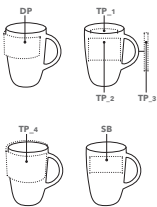

0912

ART. NO. 0912

Porcelain mug, glossy white

DIMENSIONS

Height: ~ 98 mm
Diameter: ~ 81 mm
Capacity: ~ 0.25 l

SERVICES

Colour 4U, see page 111
Packaging, see page 106-107

COLOURS



BRANDING / AREA

DP	Direct print, up to 4 colours	175 x 35 mm	TP.2	Transfer print partial cover	60 x 50 mm
SB	Sand blasting	60 x 30 mm	TP.3	Transfer print partial cover	70 x 7 mm
TP.1	Transfer print partial cover	50 x 20 mm	TP.4	Transfer print partial cover	215 x 50 mm

ELITE MATT



Engraving

0343

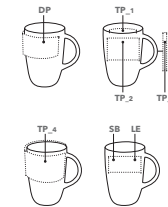

ART. NO. 0343

Stoneware mug, matt coloured

DIMENSIONS

Height: ~ 100 mm
Diameter: ~ 82 mm
Capacity: ~ 0.25 l

SERVICES

Packaging, see page 106-107

COLOURS



BRANDING / AREA

DP	Direct print	175 x 35 mm, up to 3 colours	TP.1	Transfer print partial cover	50 x 20 mm
LE	Engraving	12 cm ² (60 x 20 mm or 40 x 30 mm)	TP.2	Transfer print partial cover	60 x 50 mm
SB	Sand blasting	60 x 30 mm	TP.3	Transfer print partial cover	70 x 7 mm
			TP.4	Transfer print partial cover	215 x 50 mm

SPECIAL



0305

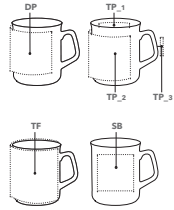

ART. NO. 0305

Porcelain mug, glossy white

DIMENSIONS

Height: ~ 95 mm
Diameter: ~ 82 mm
Capacity: ~ 0.3 l

SERVICES

Colour 4U, see page 111
Packaging, see page 106 - 107

COLOURS



BRANDING / AREA

DP Direct print	175 x 60 mm, up to 4 colours	TP_1 Transfer print partial cover	50 x 20 mm
SB Sand blasting	60 x 60 mm	TP_2 Transfer print partial cover	180 x 70 mm
TF Transfer print full cover	225 x 80 mm	TP_3 Transfer print partial cover	30 x 3 mm

MAXIM



0914

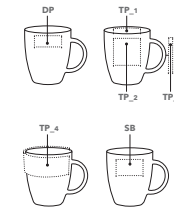

ART. NO. 0914

Porcelain mug, glossy white

DIMENSIONS

Height: ~ 99 mm
Diameter: ~ 86 mm
Capacity: ~ 0.30 l

SERVICES

Colour 4U, see page 111
Packaging, see page 106 - 107

COLOURS



BRANDING / AREA

DP Direct print	50 x 20 mm, up to 2 colours	TP_2 Transfer print partial cover	50 x 50 mm
SB Sand blasting	50 x 30 mm	TP_3 Transfer print partial cover	70 x 7 mm
TP_1 Transfer print partial cover	50 x 20 mm	TP_4 Transfer print partial cover	225 x 35 mm

MAXI MUG



0344

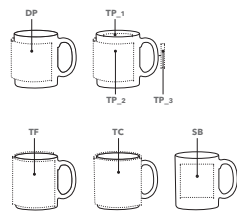

ART. NO. 0344

Porcelain mug, glossy white

DIMENSIONS

Height: ~ 96 mm
Diameter: ~ 82 mm
Capacity: ~ 0.25 l

SERVICES

Colour 4U, see page 111
Packaging, see page 106 - 107

COLOURS



BRANDING / AREA

DP Direct print	180 x 70 mm, up to 4 colours	TP_1 Transfer print partial cover	50 x 20 mm
SB Sand blasting	60 x 60 mm	TP_2 Transfer print partial cover	190 x 70 mm
TF Transfer print full cover	225 x 89 mm	TP_3 Transfer print partial cover	45 x 6 mm
TC Transfer print full cover closed	253 x 89 mm		

SWEEP



0954

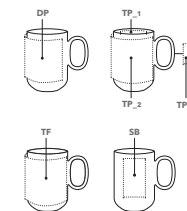

ART. NO. 0954

Porcelain mug, glossy white

DIMENSIONS

Height: ~ 110 mm
Diameter: ~ 74 mm
Capacity: ~ 0.25 l

SERVICES

Colour 4U, see page 111
Packaging, see page 106 - 107

COLOURS



BRANDING / AREA

DP Direct print	160 x 70 mm, up to 4 colours	TP_1 Transfer print partial cover	50 x 10 mm
SB Sand blasting	40 x 70 mm	TP_2 Transfer print partial cover	170 x 70 mm
TF Transfer print full cover	208 x 80 mm	TP_3 Transfer print partial cover	40 x 8 mm

CHARISMA



Direct print

Transfer print full cover

0915

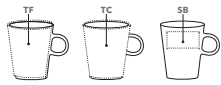
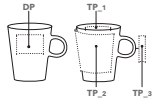

ART. NO. 0915

Porcelain mug, glossy white

DIMENSIONS

Height: ~ 100 mm
Diameter: ~ 82 mm
Capacity: ~ 0.25 l

SERVICES

Colour 4U, see page 111
Packaging, see page 106 - 107

COLOURS



BRANDING / AREA

DP	Direct print	50 x 35 mm, 2 colour	TP.1	Transfer print partial cover	50 x 20 mm
SB	Sand blasting	60 x 30 mm	TP.2	Transfer print partial cover	180 x 85 mm
TF	Transfer print full cover	200 x 96 mm	TP.3	Transfer print partial cover	50 x 12 mm
TC	Transfer print full cover closed	233 x 96 mm			

CLUB



Transfer print partial cover

0340

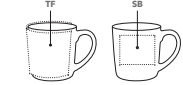
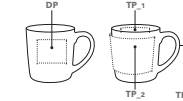

ART. NO. 0340

Porcelain mug, glossy white, suitable for coffee pad machines

DIMENSIONS

Height: ~ 88 mm
Diameter: ~ 82 mm
Capacity: ~ 0.25 l

SERVICES

Colour 4U, see page 111
Packaging, see page 106 - 107

COLOURS



BRANDING / AREA

DP	Direct print	50 x 40 mm, up to 4 colours	TP.1	Transfer print partial cover	50 x 20 mm
SB	Sand blasting	60 x 50 mm	TP.2	Transfer print partial cover	180 x 60 mm
TF	Transfer print full cover	215 x 78 mm	TP.3	Transfer print partial cover	50 x 5 mm

SOLID



Transfer print partial cover

Transfer print full cover

0944

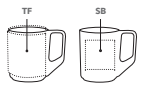
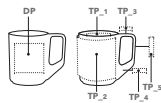

ART. NO. 0944

Porcelain mug, glossy white

DIMENSIONS

Height: ~ 99 mm
Diameter: ~ 80 mm
Capacity: ~ 0.25 l

SERVICES

Colour 4U, see page 111
Packaging, see page 106 - 107

COLOURS



BRANDING / AREA

DP	Direct print	60 x 60 mm, up to 2 colours	TP.2	Transfer print partial cover	180 x 80 mm
SB	Sand blasting	60 x 60 mm	TP.3	Transfer print partial cover	25 x 8 mm
TF	Transfer print full cover	210 x 88 mm	TP.4	Transfer print partial cover	30 x 8 mm
TP.1	Transfer print partial cover	50 x 15 mm	TP.5	Transfer print partial cover	45 x 8 mm

VERTIC



Colour 4U + Transfer print partial cover

Transfer print partial cover

0936

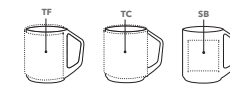
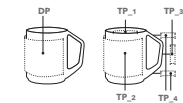

ART. NO. 0936

Porcelain mug, glossy white

DIMENSIONS

Height: ~ 101 mm
Diameter: ~ 80 mm
Capacity: ~ 0.3 l

SERVICES

Colour 4U, see page 111
Packaging, see page 106 - 107

COLOURS



BRANDING / AREA

DP	Direct print	170 x 65 mm, up to 4 colours	TP.1	Transfer print partial cover	50 x 20 mm
SB	Sand blasting	60 x 60 mm	TP.2	Transfer print partial cover	180 x 70 mm
TC	Transfer print full cover closed	246 x 89 mm	TP.3	Transfer print partial cover	40 x 10 mm
TF	Transfer print full cover	220 x 89 mm	TP.4	Transfer print partial cover	30 x 10 mm



COLOUR 4U

YOUR COLOUR. YOUR BRAND.

Our high gloss, white mugs are the perfect stage for your brand. senator® mugs can be printed or dyed in the colour of your choice, for a splendid appearance.

APPEAL



Transfer print partial cover

Colour 4U + Transfer print partial cover

0928

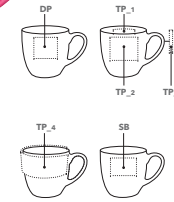

ART. NO. 0928

Porcelain mug, glossy white

DIMENSIONS

Height: ~ 94 mm
Diameter: ~ 99 mm
Capacity: ~ 0.4 l

SERVICES

Colour 4U, see page 111
Packaging, see page 106 - 107

COLOURS



BRANDING / AREA

DP	Direct print	50 x 45 mm, 1 colour	TP_2	Transfer print partial cover	60 x 50 mm
SB	Sand blasting	60 x 40 mm	TP_3	Transfer print partial cover	50 x 5 mm
TP_1	Transfer print partial cover	50 x 20 mm	TP_4	Transfer print partial cover	270 x 45 mm

COSMOS



Transfer print full cover

0926

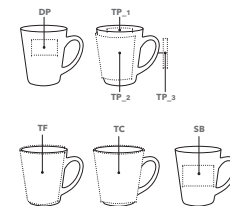

ART. NO. 0926

Porcelain mug, glossy white

DIMENSIONS

Height: ~ 106 mm
Diameter: ~ 94 mm
Capacity: ~ 0.33 l

SERVICES

Colour 4U, see page 111
Packaging, see page 106 - 107

COLOURS



BRANDING / AREA

DP	Direct print	50 x 30 mm, 1 colour	TP_1	Transfer print partial cover	50 x 20 mm
SB	Sand blasting	60 x 40 mm	TP_2	Transfer print partial cover	190 x 80 mm
TC	Transfer print full cover closed	270 x 103 mm	TP_3	Transfer print partial cover	60 x 8 mm
TF	Transfer print full cover	230 x 103 mm			

PURITY



0968

Transfer print
partial cover

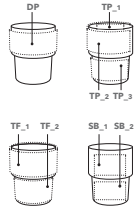

ART. NO. 0968

Porcelain mug without handle, glossy white, stackable

DIMENSIONS

Height: ~ 104 mm
Diameter: ~ 86 mm
Capacity: ~ 0.3 l

SERVICES

Colour 4U, see page 111
Packaging, see page 106-107

COLOURS



White

BRANDING / AREA

DP	Direct print	100 x 40 mm, up to 4 colours	TF_2	Transfer print full cover	215 x 43 mm
SB_1	Sand blasting	60 x 40 mm	TP_1	Transfer print partial cover	50 x 20 mm
SB_2	Sand blasting	60 x 35 mm	TP_2	Transfer print partial cover	180 x 40 mm
TF_1	Transfer print full cover	265 x 50 mm	TP_3	Transfer print partial cover	180 x 30 mm

PURITY PLUS



0368

Transfer print
partial cover

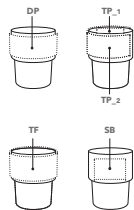

ART. NO. 0368

Porcelain mug without handle, glossy white, with a choice of 4 coloured decorative sleeves, stackable

DIMENSIONS

Height: ~ 104 mm
Diameter: ~ 86 mm
Capacity: ~ 0.3 l

SERVICES

Colour 4U, see page 111
Packaging, see page 106-107
PMS Service: decorative sleeve: from 1,000 pcs.

COLOURS

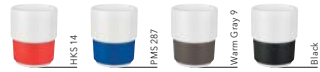

RHS 14

PMS 287

Warm Gray 9

Black

BRANDING / AREA

DP	Direct print	100 x 40 mm, up to 4 colours	TP_1	Transfer print partial cover	50 x 20 mm
SB	Sand blasting	60 x 40 mm	TP_2	Transfer print partial cover	180 x 40 mm
TF	Transfer print full cover	265 x 50 mm			

FANCY Start-Up Box



0951

Transfer print
partial cover

ART. NO. 0951

Porcelain set of 74 pieces:
24 cups and saucers, 24 plates,
1 milk jug, 1 sugar bowl

DIMENSIONS

Height cup: ~ 70 mm
Diameter cup: ~ 82 mm
Capacity cup: ~ 0.2 l
Diameter saucer: ~ 144 mm
Diameter plate: ~ 210 mm
milk jug: ~ 78 mm
sugar bowl: ~ 58 mm
(with lid ~ 90 mm)

COLOURS



White

BRANDING / AREA

TP_1	Transfer print partial cover	40 x 20 mm
------	------------------------------	------------

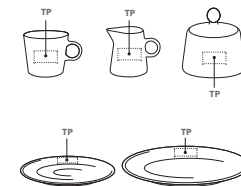

FANCY

Espresso Set + Espresso Duo



0964 + 0984

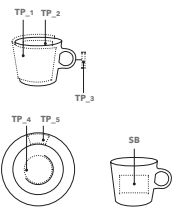

ART. NO. 0964

Espresso Set
Porcelain espresso cup and saucer,
glossy white

DIMENSIONS

Height: ~ 57 mm
Diameter: ~ 67 mm
Capacity: ~ 0.13 l
Diameter saucer: ~ 120 mm

COLOURS



BRANDING / AREA

SB Sand blasting	40 x 15 mm	TP.3 Transfer print partial cover	30 x 3 mm
TP.1 Transfer print partial cover	170 x 55 mm	TP.4 Transfer print partial cover	Ø 45 mm
TP.2 Transfer print partial cover	40 x 5 mm	TP.5 Transfer print partial cover	50 x 15 mm

ART. NO. 0984

Espresso Duo
2 porcelain espresso cups and saucers,
glossy white, in gift box

FANCY

Plates



0966

0993

0994

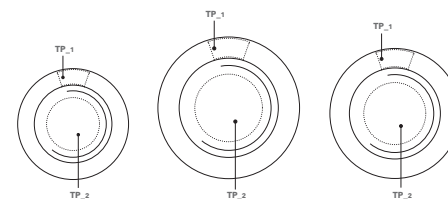

ART. NO. 0966

Porcelain plate, glossy white

ART. NO. 0993

Porcelain dinner plate, glossy white

DIMENSIONS

Diameter plate: ~ 213 mm
Diameter dinner plate: ~ 263 mm
Diameter soup plate: ~ 225 mm

COLOURS



BRANDING / AREA 0966

TP.1 Transfer print partial cover	40 x 20 mm	TP.2 Transfer print partial cover	Ø 100 mm
--	------------	--	----------

BRANDING / AREA 0993

TP.1 Transfer print partial cover	100 x 20 mm	TP.2 Transfer print partial cover	Ø 100 mm
--	-------------	--	----------

BRANDING / AREA 0994

TP.1 Transfer print partial cover	80 x 20 mm	TP.2 Transfer print partial cover	Ø 100 mm
--	------------	--	----------

FANCY

Café Set



0965

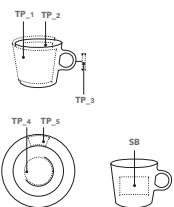

ART. NO. 0965

Porcelain cup and saucer, glossy white

DIMENSIONS

Height: ~ 70 mm
Diameter: ~ 82 mm
Capacity: ~ 0.2 l
Diameter saucer: ~ 144 mm

COLOURS



BRANDING / AREA

SB Sand blasting	40 x 30 mm	TP.3 Transfer print partial cover	30 x 5 mm
TP.1 Transfer print partial cover	195 x 60 mm	TP.4 Transfer print partial cover	Ø 55 mm
TP.2 Transfer print partial cover	50 x 20 mm	TP.5 Transfer print partial cover	40 x 20 mm

FANCY

Bowl



0920

Transfer print full cover

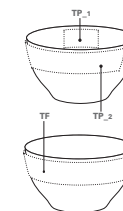

ART. NO. 0920

Porcelain bowl, glossy white

DIMENSIONS

Height: ~ 76 mm
Diameter: ~ 141 mm
Capacity: ~ 0.65 l

COLOURS



BRANDING / AREA

TF Transfer print full cover	420 x 30 mm	TP.1 Transfer print partial cover	50 x 30 mm
		TP.2 Transfer print partial cover	210 x 30 mm



MAXIM

MORE THAN JUST A MUG.



For a corporate design down to the detail:
We brand your corporate tableware for a stylish appearance in conferences, the office and the coffee lounge.

MAXIM CAFÉ



0907

Transfer print partial cover

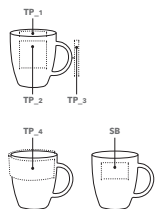

ART. NO. 0907

Porcelain mug, glossy white

DIMENSIONS

Height: ~ 82 mm
Diameter: ~ 80 mm
Capacity: ~ 0.2 l

COLOURS



BRANDING / AREA

SB Sand blasting	40 x 30 mm	TP_3 Transfer print partial cover	50 x 5 mm
TP_1 Transfer print partial cover	40 x 5 mm	TP_4 Transfer print partial cover	215 x 20 mm
TP_2 Transfer print partial cover	40 x 50 mm		

SERVICES

Colour 4U, see page 111
Packaging, see page 106-107

MAXIM Espresso Set + Espresso Duo



Transfer print partial cover

0977 + 0987

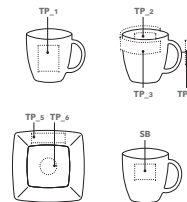

ART. NO. 0977

Espresso Set
Porcelain espresso cup and saucer,
glossy white

ART. NO. 0987

Espresso Duo
2 porcelain espresso cups and saucers,
glossy white, in gift box

DIMENSIONS

Height: ~ 55 mm
Diameter: ~ 60 mm
Capacity: ~ 0.13 l
Diameter saucer: ~ 116 mm

COLOURS



BRANDING / AREA

SB Sand blasting	40 x 15 mm	TP_4 Transfer print partial cover	30 x 3 mm
TP_1 Transfer print partial cover	30 x 40 mm	TP_5 Transfer print partial cover	55 x 15 mm
TP_2 Transfer print partial cover	30 x 5 mm	TP_6 Transfer print partial cover	Ø 25 mm
TP_3 Transfer print partial cover	170 x 10 mm		

MAXIM Café Set



Transfer print partial cover

0937

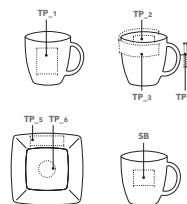

ART. NO. 0937

Porcelain cup and saucer,
glossy white

DIMENSIONS

Height: ~ 81 mm
Diameter: ~ 79 mm
Capacity: ~ 0.2 l
Diameter saucer: ~ 148 mm

COLOURS



BRANDING / AREA

SB Sand blasting	40 x 30 mm	TP_4 Transfer print partial cover	50 x 5 mm
TP_1 Transfer print partial cover	40 x 50 mm	TP_5 Transfer print partial cover	70 x 20 mm
TP_2 Transfer print partial cover	40 x 5 mm	TP_6 Transfer print partial cover	Ø 35 mm
TP_3 Transfer print partial cover	215 x 20 mm		

MAXIM Plates



0927



0997



0998

Transfer print
partial cover

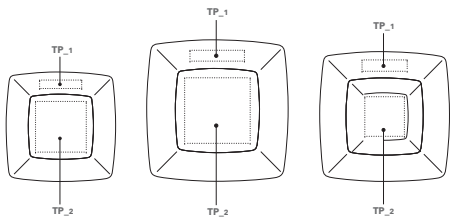

ART. NO. 0927

Porcelain plate, glossy white

ART. NO. 0997

Porcelain dinner plate, glossy white

ART. NO. 0998

Porcelain soup plate, glossy white

DIMENSIONS

Diameter plate: ~210 mm
Diameter dinner plate: ~260 mm
Diameter soup plate: ~230 mm

COLOURS



BRANDING / AREA 0927

TP_1 Transfer print partial cover 70 x 25 mm

TP_2 Transfer print partial cover 100 x 100 mm

BRANDING / AREA 0997

TP_1 Transfer print partial cover 100 x 20 mm

TP_2 Transfer print partial cover 100 x 100 mm

BRANDING / AREA 0998

TP_1 Transfer print partial cover 80 x 20 mm

TP_2 Transfer print partial cover 70 x 70 mm

MAXIM Start-Up Box



Transfer print
partial cover

0952

ART. NO. 0952

Porcelain set of 74 pieces:
24 cups and saucers, 24 plates,
1 milk jug, 1 sugar bowl

DIMENSIONS

Height cup: ~81 mm
Diameter cup: ~79 mm
Capacity cup: ~0.2 l
Diameter saucer: ~150 mm
Diameter plate: ~210 mm
Height milk jug: ~79 mm
Height sugar bowl: ~78 mm
(with lid ~115 mm)

COLOURS



BRANDING / AREA

TP Transfer print partial cover 40 x 20 mm

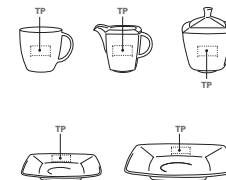

PACKAGING



P1A
P1A XL



P1B
P1B XL



P2
P2 XL



P4

ART. NO. P1A

Cardboard box, white;
for 1 mug
Size: 125 × 90 × 120 mm

ART. NO. P1A XL

Cardboard box, white;
for 1 big mug
Size: 130 × 110 × 120 mm

ART. NO. P1B

Cardboard box, white; with viewing
window; for 1 mug
Size: 115 × 93 × 120 mm

ART. NO. P1B XL

Cardboard box, white; with viewing
window; for 1 big mug
Size: 115 × 115 × 125 mm

ART. NO. P2

Cardboard box, white;
for 2 mugs
Size: 220 × 90 × 120 mm

ART. NO. P2 XL

Cardboard box, white;
for 2 big mugs
Size: 225 × 115 × 115 mm

ART. NO. P4

Cardboard box,
white; for 4 mugs
Size: 220 × 120 × 220 mm

PACKAGING



P6



P36



Café set

Espresso set or
duo set



Packaging slip case

ART. NO. P6

Cardboard box, white;
for 6 mugs
Size: 215 × 120 × 325 mm

ART. NO. P36

Cardboard box, brown;
for 36 mugs
Size: 540 × 360 × 390 mm

ESPRESSO SET / DUO SET

Cardboard box, white;
for 1 or 2 espresso sets
Size: 132 × 110 × 132 mm

CAFÉ SET

Cardboard box, white;
for 1 or 2 café sets
Size: 172 × 172 × 155 mm

PACKING SLIP CASE

Individually customisable;
sizes and print areas on request

BRANDING METHODS PENS



HIGH DEFINITION PRINT

The world-wide unique digital direct print convinces by its brilliance, colour and feel.

Technology:

This printing method delivers a surface like a steel engraved business card on a promotional pen. Instead of a simple, yet absolutely flat image as common print technologies, the senator® high definition print enables a brand experience like you have never seen and felt before.

Strengths:

- Incomparable 3D effect
- Realisation of complex colour gradients
- Accurate reproduction of photo-realistic themes
- Reproduction of countless colours



DIGITAL CLIP PRINT / DIGITAL CAP PRINT

Our Digital Clip Print is the perfect solution to apply multi coloured prints on the clips of our ball pens.

With this method we also place logos very effectively onto the cap of our Liberty models with plastic clip.

Technology:

The digital print uses the CMYK colour printing process to mix all colours from the basic four. For prints on coloured clips we apply an extra layer in white underneath the print.

Strengths:

- Print to the edge of the clip possible
- Realisation of colour gradients
- Also suitable for photo-realistic theme



SCREEN PRINT

Whenever it comes to branding our ball pen barrels or flat clips for us at senator® screen print is the branding method of our choice. The colours used allow a nearly exact reproduction of your corporate colours.

Technology:

Screenprint is a direct print process whereby ink is pressed through a mesh onto the ball pen. This process allows a very even ink application.

Strengths:

- Particularly sharp-edged prints
- Large areas printable
- Very precise register accuracy for multi-colour prints



TAMPO PRINT

Tampo print is particularly suitable for printing on variously shaped or surface structured objects. We therefore use this printing method for branding our ball pen clips.

Technology:

Tampo print is an indirect print method whereby ink is transferred from the cliché via an elastic pad onto the surface to be printed. The result is a very even print on curved objects.

Strengths:

- Best suited to print on curved objects
- Also for printing on small parts
- Multi colour prints possible

BRANDING METHODS PENS



BARREL PRINT 360°

When it comes to printing all around our cylindrical barrels to use a very large area the Barrel Print 360° is first choice.

Prints with up to 5 colours can be effectively realised.

Technology:

Senator® 360° barrel print is a special screen printing process whereby the barrel of a ball pen is printed before assembly. This way we can print all around the barrel and even underneath the clip.

Strengths:

- Eye-catching results
- Large printing area
- High register accuracy



BARREL PRINT 360° PLUS

360° Barrel Print Plus is the evolution of our 360° Barrel Print. Here we add an additional lacquer layer onto the print for a shiny and palpable effect.

Technology:

The lacquer layer substitutes one colour of the 360° Barrel Print and can be combined with prints of up to 4 colours.

Strengths:

- Palpable 3D surface
- Accentuation of selected elements
- Large printing area
- Solid tone prints possible



METAL PRINT

The surfaces of our metal pens are refined by varnishes, lacquers or other surface coatings.

In order to achieve a good bonding of the ink and wear resistance on these surfaces we use our special Metal Print method.

Technology:

Senator® metal print is a screen printing process whereby an extra hardening step is added in order to achieve a long lasting print result.

Strengths:

- Lasts on varnished surfaces
- Brilliant colours



LASER ENGRAVING

A very elegant branding method on metal surfaces is a laser engraving. Logos or messages are very accurately and permanently worked into the metal surface.

Technology:

For our laser engraving we use a high precision computer-controlled laser to engrave the surface of our writing instruments and thus expose the metal layer underneath.

Strengths:

- A high class and modest result
- Strong with fine lines
- Also suitable for single names

REFILLS

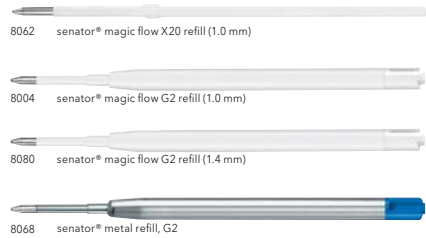

senator. magic flow

The refill is a decisive part of the ball pen and contributes considerably to the success of the product. Therefore, when choosing a promotional ball pen, its inner values should be a primary consideration.

A high quality refill ensures a more pleasurable writing experience and guarantees higher levels of exposure and a better economic return for brands.

The **senator® magic flow** refill is one of the best in its class:

- Continuous writing with no spots of ink
- Thanks to a high quality ball and new writing ink in premium quality, this refill offers an extremely smooth and even writing experience
- In two widths:
1.0 mm for all who prefer a clear and fine line
1.4 mm for all who like the lines being a bit stronger
- Indelible to ISO-12757-1 + 2 and tested under stringent quality criteria to the highest demands

BALL PEN REFILLS

Each senator® ball pen is equipped with the perfectly matching refill. We only use tested and standardised quality refills and guarantee:

- Fixed minimum filling quantities for each refill
- Indelibility to ISO-12757-1 + 2
- Compliance with customary refill systems

ROLLERBALL REFILLS

A characteristic of our senator® rollerball refill is the long "Cap-Off" time. A rollerball can easily be left on the table without its cap and will start writing any time.

COLOUR 4U



COLOUR 4U

The right colour for your mug

Bring your corporate colour to life with our Colour 4U service. Tell us your desired colour and we will dye the exterior of your chosen mug to create the perfect eye-catcher.

We hold a large variety of both ceramic and organic (Polylux) colours to choose from.

This service is available on all senator® white porcelain mug ranges, except for sets.

We will be happy to assist you with the selection of your colour.



CERAMIC COLOURS

Ceramic colours bond with the mug's surface at temperatures of more than 800° C. This makes them extremely long lasting. However, owing to the substances ceramic colours are made of, it is unfortunately not possible to offer every imaginable colour. These colours are suitable for use in standard dishwashers.

POLYLUX COLOURS

Polylux (organic) colours can achieve an incredibly broad colour range. For all colour shades that cannot be achieved with ceramic colours, our polylux colours are the right choice. Please note that these colours only tolerate lower burning temperatures and are therefore not as long lasting as ceramic colours. Even though these colours are suitable for use in standard dishwashers, we recommend hand washing.

For all senator® mugs with EU origin, only polylux colours can be used.

BRANDING METHODS MUGS



DIRECT PRINT

With the Direct Print method we apply the ink directly onto the mug. This saves time and money.

Many of our mug models are suited for up to 4-colour prints, for some models this print method is restricted to 2 colours.

Some print designs cannot be reproduced with the Direct Print method. We will be happy to evaluate your logo prior to printing to make sure this print method is best suited for your project.

The dimensions for the brandings stipulated in the catalogue are valid for most of the logos. Restrictions may occur depending on the logo.

The strengths of this branding technique are:

- Short delivery times
- Cost-effective branding method
- Strong with line prints

TRANSFER PRINT, PARTIAL COVER

Transfer Print is a branding method by which we first print the design on a label to be applied onto the mug in a second step. During the firing process the colour combines with the mug surface, the label dissolves up to a small edge around the print design.

The strengths of this branding technique are:

- Endless variety
- Strong with half-tone prints
- Nearly perfect with colour gradients

TRANSFER PRINT, FULL COVER

The Full Cover version of our transfer print is applied onto a considerably larger area.

For all products that are suited for this large area branding please refer to our product pages in this catalogue.

The strengths of this branding technique are:

- Full cover print
- Perfect customisation method
- Large branding area.

TRANSFER PRINT, FULL COVER CLOSED

Some of our mug models can be branded on an even larger area using the additional area around or underneath the handle.

For all products that are suited for this large area branding please refer to our product pages in this catalogue.

The strengths of this branding technique are:

- Use of the complete area
- Perfect customisation

BRANDING METHODS MUGS



SANDBLASTING

With the Sandblasting method we grind the design direct into the surface giving the logo depth and structure.

The strengths of this branding technique are:

- Striking tactile results
- Perfect for coloured mugs
- Provides depth and structure

LASER ENGRAVING

A computer-controlled laser engraves a logo or imprint into the item ensuring absolute definition and longlasting branding.

The strengths of this branding technique are:

- Understated quality
- Precise reproduction of logos and lettering

SUBLIMATION

The sublimation process uses pressure and heat to transfer the graphic onto a specially coated mug.

We offer this impressive branding method for a total of 9 different mug designs.

The strengths of this branding technique are:

- High colour variety and brilliance
- Photo realistic prints possible
- Already available for small quantities from 36 pieces

COLOUR 4U

Name your requested colour and we dye the outside of your mug to your requirements.

This is possible for all white porcelain and stoneware mugs in our senator® range except for our tableware sets.

The strengths of this branding technique are:

- Supremely customisable
- Colour matching on request

GLOSSY IMPRESSION

With this special branding method we treat the frosted glass surface with a special lacquer. This makes the surface clear transparent again resulting in an eye-catching contrast of transparent and frosted surfaces.

The strengths of this branding technique are:

- Patented process
- Unique effects
- Subtle and harmonious

All of our branding methods are suitable for dishwashers. For some branding techniques, such as gold, or our thermo mugs, however, we recommend hand washing. Should you require further information, please contact your senator® customer service team.

ARTWORK

GENERAL INFORMATION

Please send us your artwork in the below mention file types or send text in on of our standard typefaces.

Please also provide a print sample or proof if possible.

Please send logos and text as vectorised files or as TIF-files with 1200 dpi, in case of photos we require a resolution of 600 dpi. Vectorised logos can be scaled without any loss in quality and are to be preferred against pixel files.

Below mentioned minimum font sizes and minimum line widths are guidelines only. Depending on the motive, branding method or product surface smaller letters and finer lines might be possible or larger letters or bigger lines might be necessary.

Proof samples

To make sure you get the best possible result we recommend the production of a sample for approval. (For production reasons slight colour deviations between a print on paper and a print on other materials are unavoidable).

File formats Mac and PC

Adobe Photoshop CC 2018
Adobe Illustrator CC 2018
Adobe Indesign CC 2018
(Please convert all texts into curves)

Dateiformate PC

Corel Draw X8
(Please convert all texts into curves)

Print positions and dimensions

For all information on print positions and dimensions please refer to the product pages of the catalogue.

PENS

Print colours

With the available colour shade mixing range, all Pantone C and HBP K shades can be mixed. Slight colour shade deviations between paper flags and print are unavoidable on white underground. Major colour shade deviations on an underground of a different colour shade or on a dark-shaded underground must be tolerated.

Digital Print

All colours are mixed in CMYK, so it is not possible to print real PMS colours. In nearly every case the colours will be close to.

Very large, uni coloured surfaces cannot be realised.
Minimum size: 8 pt, minimum line width: 0.15 mm

Personalisation (list of names)

Many of our products can be customised with the personal name. Please send us the names in an excel file.

Raster

Screen print: Raster of 40, colour intensity 15 - 85%.
360° barrel print: Raster of 48, colour intensity 15 - 85%.

Standard Typefaces

Arial, AvantGarde, Courier, Futura, Present, Serifa, Helvetica, Times New Roman, Univers each regular, bold, italic, bold italic, BrushScript, English script tye each italic and bold italic. Other typefaces possible (only PC), please send font as True Type-face (*.ttf).

Other or similar typefaces on request.

MUGS

Direct Print

On white mugs or glasses

Without trapping in the design:

Minimum size 10 pt, minimum line width 0.2 mm, no raster

With trapping in the design:

Minimum size 10 pt, minimum line width 0.5 mm, no raster

On coloured mugs and glasses a white layer will always have to be layed underneath:

Minimum size 24 pt, minimum line width 0.8 mm, no raster

Transfer print on glass, stainless steel and coloured mugs

Minimum size 12 pt, minimum line width 0.35 mm, printable colour intensity 15 - 85 %

Laser engraving on stainless steel

Minimum size 8 pt, minimum line width 0.2 mm

Laser engraving on coloured mugs

Minimum size 12 pt, minimum line width 0.4 mm

Personalisation (list of names)

A great variety of our mugs can be customised with the personal name. Please send us the names in an excel file. Please note that this very special way of customisation is always possible when the name stands for itself and is not part of the remaining design.

Sandblasting

Minimum size 24 pt, minimum line width 1 mm, no raster

Sublimation

Minimum size: positive 8 pt, negative 10 pt
Minimum line width: positive 0.2 mm, negative 0.3 mm, no raster

Transfer Print

Minimum size 8 pt, minimum line width 0.2 mm, printable colour intensity 15 - 85 %

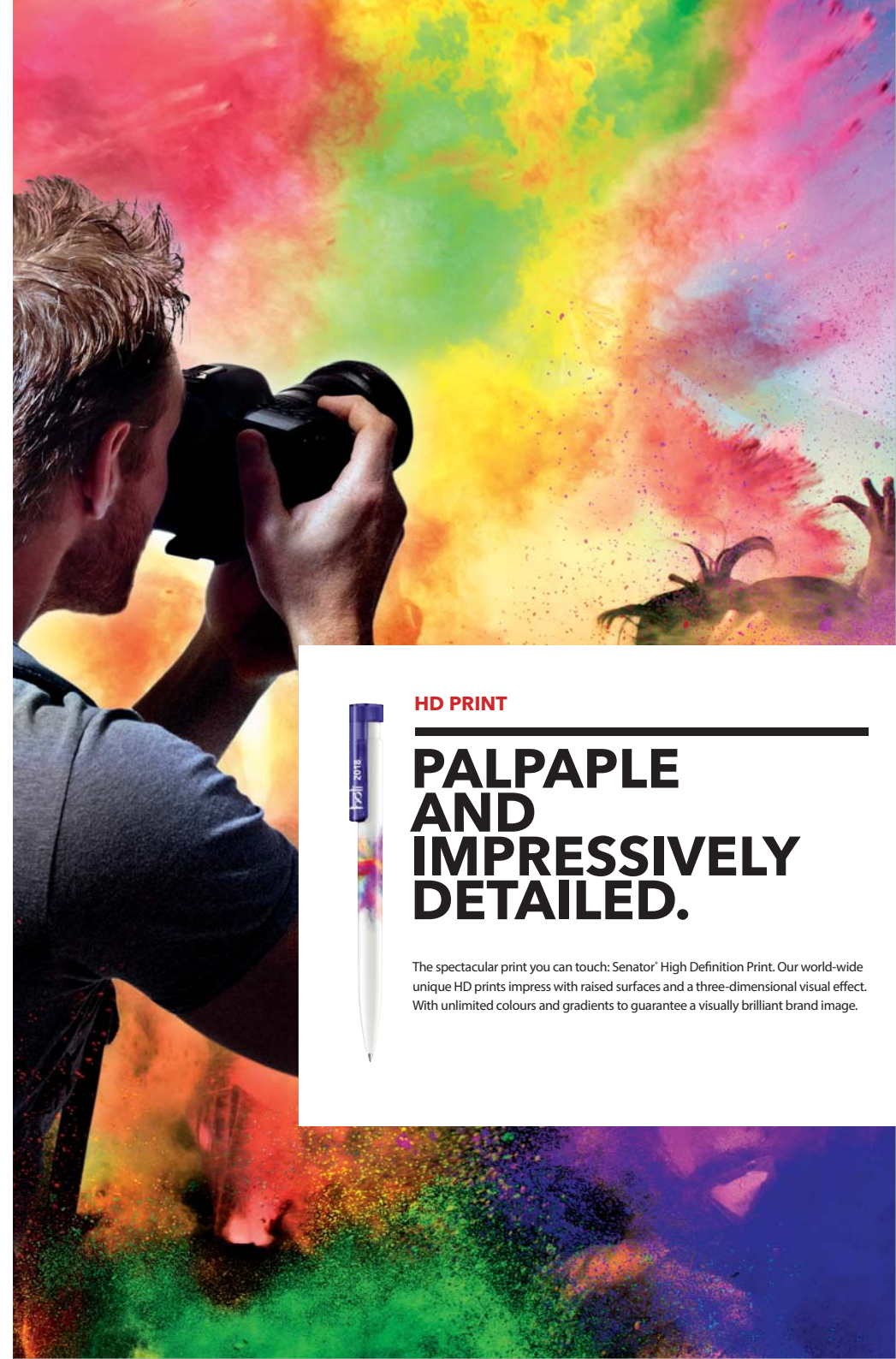

HD PRINT



PALPABLE AND IMPRESSIVELY DETAILED.

The spectacular print you can touch: Senator® High Definition Print. Our world-wide unique HD prints impress with raised surfaces and a three-dimensional visual effect. With unlimited colours and gradients to guarantee a visually brilliant brand image.

Valid from Jan. 1, 2018

Whilst our catalogues are prepared with utmost care SENATOR GmbH cannot guarantee the completeness and accuracy of the information provided.

Our general terms apply. You will find these at www.senator.com

PALPABLE PRINTS BY SENATOR.

Choose one of senator®'s raised print methods for advertising that looks good, and feels even better.

BARREL PRINT 360° PLUS

NEW

Opt for our lacquer layer technology to make your logo touchable and high-gloss shiny.



HIGH DEFINITION PRINT

With the world wide unique digital direct print you get a brilliant print result that you can feel, whilst achieving unlimited colour gradients.